

PMSMMC56F80000EVK

MCUXpresso SDK Field-Oriented Control (FOC) of 3-Phase PMSM and BLDC motors

Rev. 0 — 20 December 2022

User guide

1 Introduction

This user's guide describes the implementation of the sensorless Motor Control software for the 3-phase Permanent Magnet Synchronous Motor (PMSM), including the motor parameters identification algorithm, on the NXP MCU based on the 56800EX or 56800EF DSP architecture. The sensorless control software and PMSM control theory in general are described in *Sensorless PMSM Field-Oriented Control* (document [DRM148](#)). The NXP Freedom board ([FRDM-MC-LVPMSM](#)) or NXP Tower board ([TWR-MC-LV3PH](#)) is used as hardware platform for the PMSM control reference solution. The hardware-dependent part of the sensorless control software, including a detailed peripheral setup and the Motor Control (MC) peripheral drivers, is addressed as well. The motor parameters identification theory and algorithms are described in this document. The last part of the document introduces and explains the user interface represented by the Motor Control Application Tuning ([MCAT](#)) page based on the FreeMASTER run-time debugging tool. These tools present a simple and user-friendly way for motor parameter identification, algorithm tuning, software control, debugging, and diagnostics.

The software provides the sensorless field-oriented speed, torque, and scalar control. You can control the application using the board buttons or the FreeMASTER application. The motor identification and application tuning is done using the MCAT tool integrated in the FreeMASTER page. The required software, hardware setup, jumper settings, project arrangement, and user interface is described in the following sections. For more information, visit www.nxp.com/motorcontrol_pmsm.

Note: The latest documentation for the motor control SDK is available on http://www.nxp.com/motorcontrol_pmsm.

2 Hardware setup

The PMSM Field-Oriented Control (FOC) application runs on the following platforms: FRDM-MC-LVPMSM or TWR-MC-LV3PH development platforms with the default configuration for the Linux 45ZWN24-40 motor or on the HVP (HVP-MC3PH) development platform with the default configuration for the MIGE 60CST-MO1330 motor. Supported development platforms for the device described in this document are mentioned below.

2.1 FRDM-MC-LVPMSM

This evaluation board, in a shield form factor, effectively turns an NXP Freedom development board or an evaluation board into a complete motor-control reference design, compatible with existing NXP Freedom development boards and evaluation boards. The Freedom motor-control headers are compatible with the Arduino™ R3 pin layout.

The FRDM-MC-LVPMSM low-voltage, 3-phase Permanent Magnet Synchronous Motor (PMSM) Freedom development platform board has the power supply input voltage of



MCUXpresso SDK Field-Oriented Control (FOC) of 3-Phase PMSM and BLDC motors

24-48 VDC with a reverse polarity protection circuitry. The auxiliary power supply of 5.5 VDC is created to supply the FRDM MCU boards. The output current is up to 5 A RMS. The inverter itself is realized by a 3-phase bridge inverter (six MOSFETs) and a 3-phase MOSFET gate driver. The analog quantities (such as the 3-phase motor currents, DC-bus voltage, and DC-bus current) are sensed on this board. There is also an interface for speed and position sensors (encoder, hall). The block diagram of this complete NXP motor-control development kit is shown in [Figure 1](#).

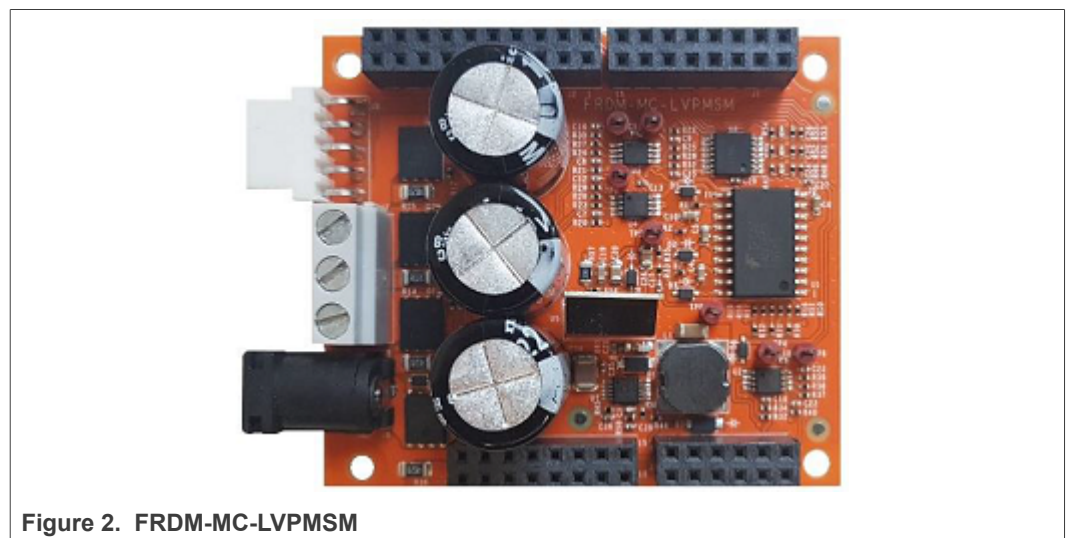
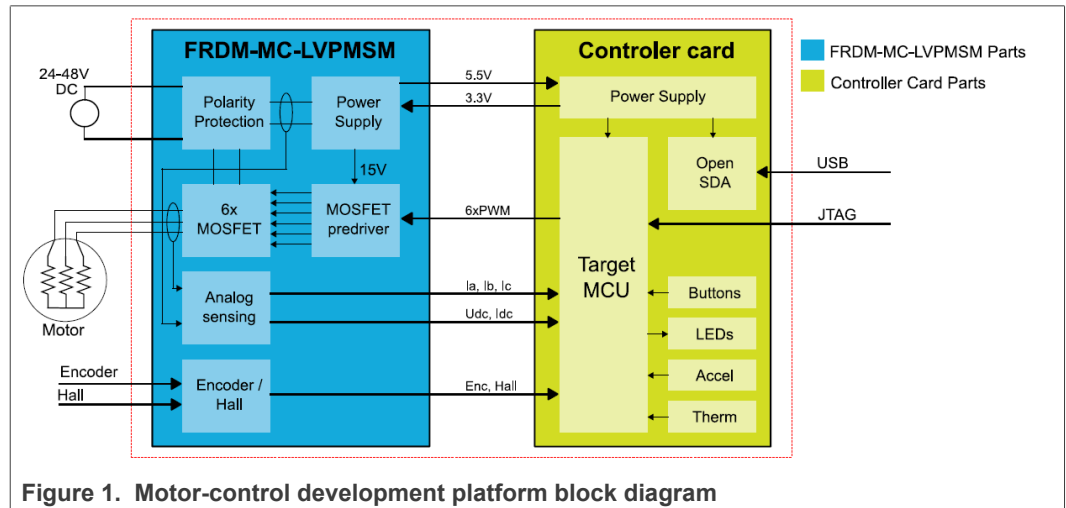

The FRDM-MC-LVPMSM board does not require a complicated setup. For more information about the Freedom development platform, see www.nxp.com.

Note: There might be a wrong FRDM-MC-LVPMSM series on the market (series VV19520XXX). This series is populated with 10mOhm shunt resistors and noisy operational amplifiers which affects phase current measurement. The `mc_pmsm` example is tuned for original FRDM-MC-LVPMSM board with 20mOhm shunt resistors.

2.2 Linux 45ZWN24-40 motor

The Linux 45ZWN24-40 motor is a low-voltage 3-phase permanent-magnet motor with hall sensor used in PMSM applications. The motor parameters are listed in [Table 1](#).

Table 1. Linix 45ZWN24-40 motor parameters

Characteristic	Symbol	Value	Units
Rated voltage	Vt	24	V
Rated speed	-	4000	RPM
Rated torque	T	0.0924	Nm
Rated power	P	40	W
Continuous current	Ics	2.34	A
Number of pole-pairs	pp	2	-



Figure 3. Linix 45ZWN24-40 permanent magnet synchronous motor

The motor has two types of connectors (cables). The first cable has three wires and is designated to power the motor. The second cable has five wires and is designated for the hall sensors' signal sensing. For the PMSM sensorless application, only the power input wires are needed.

2.3 MC56F80000-EVK

The MC56F80xxx development board is an ideal platform for evaluation and development with the MC56F80xxx MCU based on the 56800EF DSP architecture. The board includes the high-performance on-board debug probe. Configure the jumper settings according to [Table 2](#) for the motor-control application to work properly.

Table 2. MC56F80000-EVK jumper settings

Jumper	Setting	Jumper	Setting	Jumper	Setting
J5	close	J16	close	J22	open
J6	close	J17	close	J23	open
J8	2-3	J18	open	J24	close
J11	2-3	J19	close	J25	close
J13	1-2, 3-4, 5-6, 7-8	J20	open		
J15	close	J21	close		

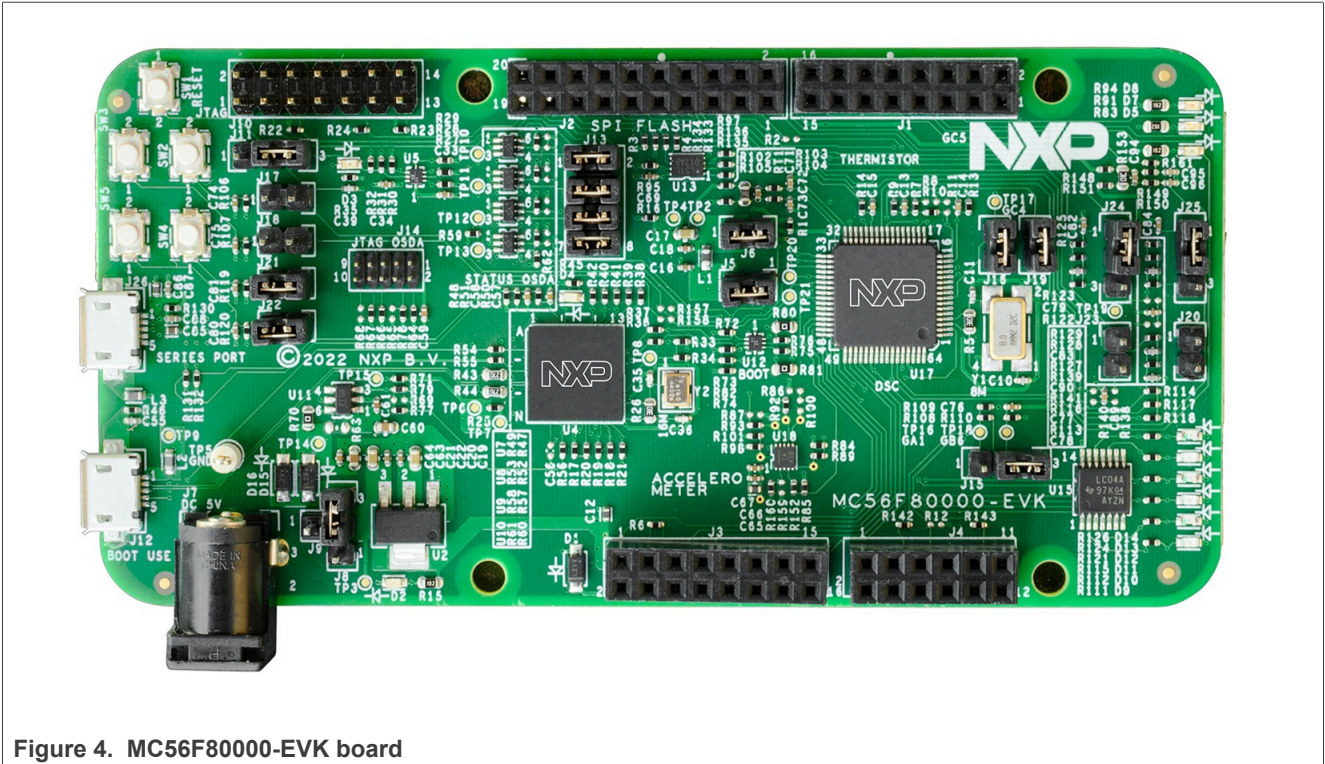

Figure 4. MC56F80000-EVK board

2.3.1 Hardware assembling

1. Plug the FRDM-MC-LVPMSM power stage to the MC56F80000-EVK board.
2. Connect the 3-phase motor wires to the screw terminals J7 on the FRDM-MC-LVPMSM.
3. Plug the USB cable from the USB host to the USB connector J12 on the EVK board.
4. Compile the project and program the MC56F80000-EVK board prior to plugging 24V DC to FRDM-MC-LVPMSM. Plugging 24V DC to a non-programmed board could cause a shoot through top and bottom transistors.
5. Plug the 24-V DC power supply into the DC power connector on the Freedom PMSM power stage. (After code is run on MCU)

3 MC56F8xxxx series features and peripheral settings

This section describes the peripheral settings and application timing. The MC56F8xxxx MCU series contains a high-performance 56800EX or 56800EF DSP core. It combines the best features of Microcontrollers (MCUs) and powerful Digital Signal Processing (DSP) capabilities in a single chip. The MC56F8xxxx MCU series are optimized for digital signal processing and applications ranging from general embedded markets to motor control and power conversion. In addition, the MC56F8xxxx MCU series features several scalable families with broad package and memory options, as well as the comprehensive MCUXpresso software and tools ecosystem and low-cost development boards.

3.1 MC56F80xxx

The MC56F80xxx is a cost-effective DSC family based on high-performance 100MHz 56800EF DSP core. It is NXP's first digital signal controller (DSC) family with integrated

MCUXpresso SDK Field-Oriented Control (FOC) of 3-Phase PMSM and BLDC motors

FPU and TMU (Trigonometric Math Unit), providing high-performance cost-effective solutions for digital power conversion and motor control applications. This product family combines the processing power of a DSP and the functionality of an MCU, with a flexible set of peripherals to support different applications. The MC56F80xxx includes advanced high-speed and high-accuracy peripherals such as 8 channel eFlexPWM with 312 ps resolution, dual high-speed 12-bit ADCs, two operational amplifiers and three analog comparators.

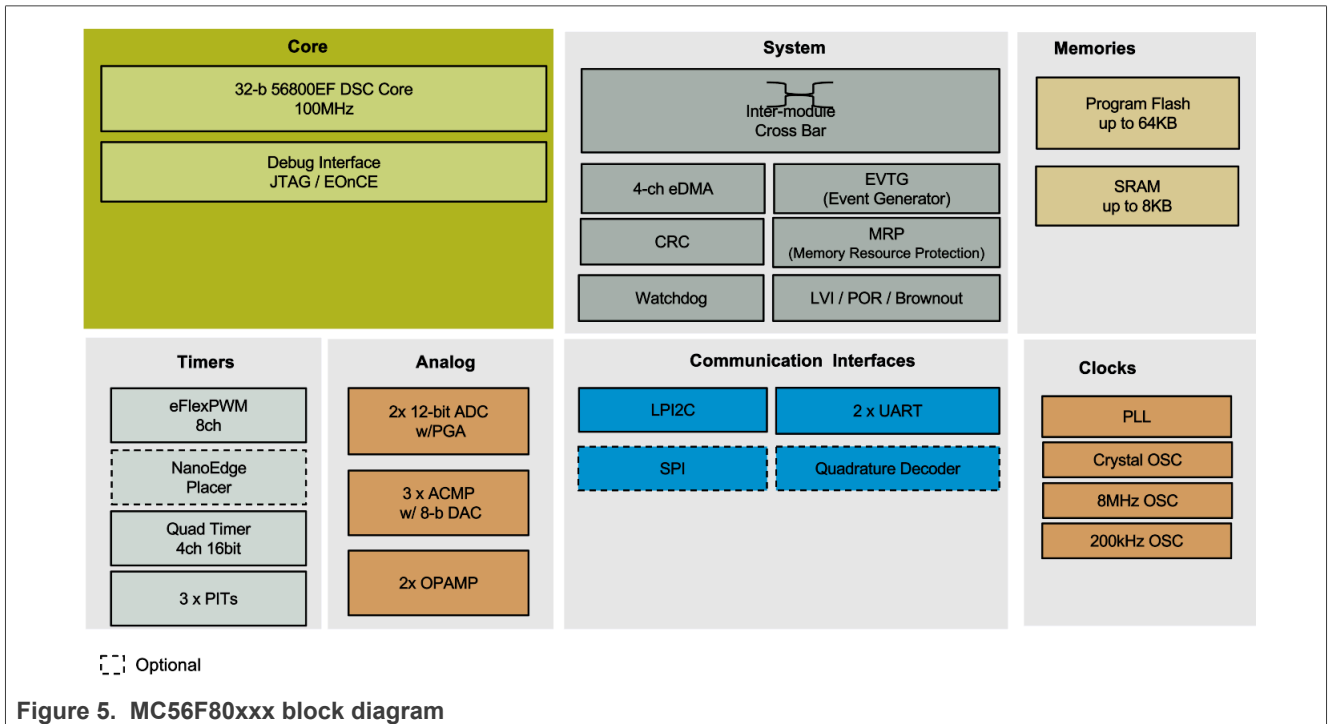

3.1.1 MC56F80748 - Hardware timing and synchronization

Correct and precise timing is crucial for motor-control applications. Therefore, the motor-control-dedicated peripherals take care of the timing and synchronization on the hardware layer. In addition, it is possible to set the PWM frequency as a multiple of the ADC interrupt (ADC ISR) frequency where the FOC algorithm is calculated. In this case, the PWM frequency is equal to the FOC frequency. The timing diagram is shown in [Figure 6](#).

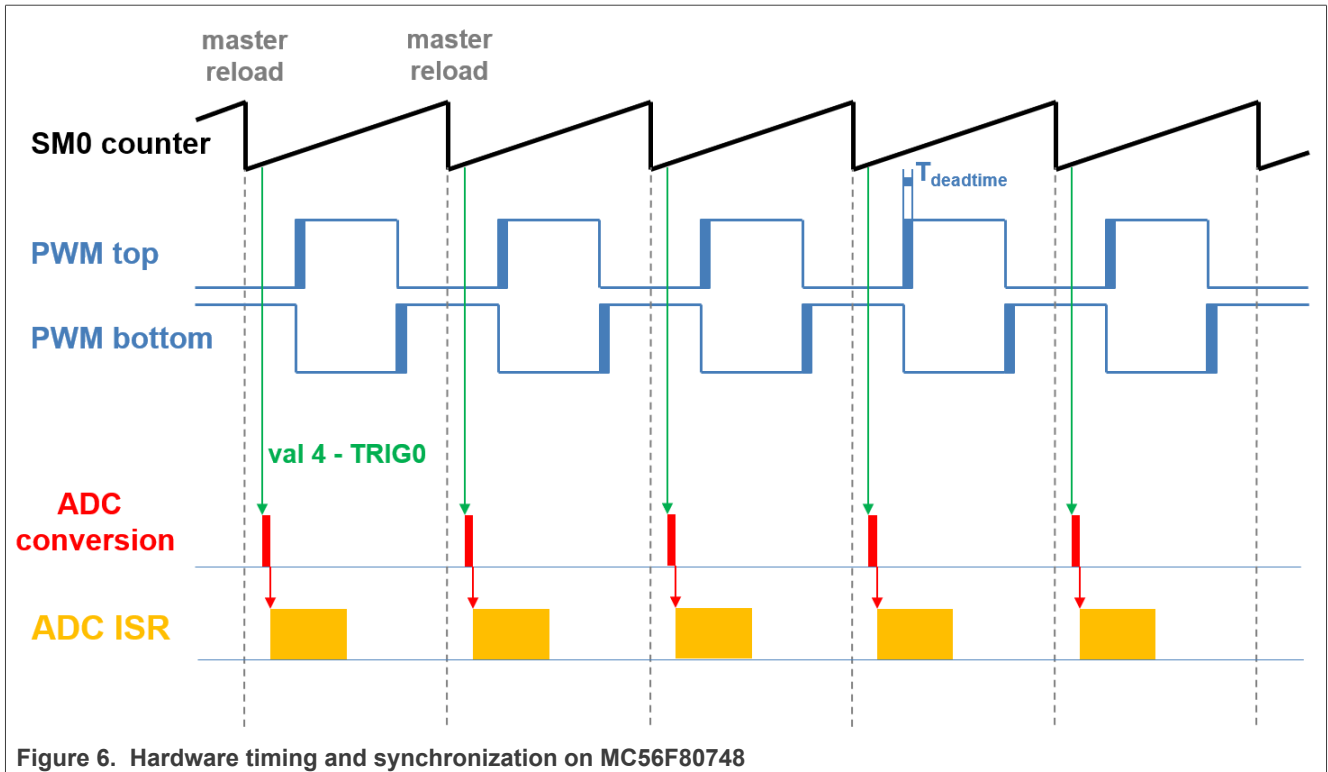

Figure 6. Hardware timing and synchronization on MC56F80748

- The top signal shows the eFlexPWM counter (SM0 counter). The dead time is emphasized at the PWM top and PWM bottom signals. The SM0 submodule generates the master reload at every opportunity.
- The SM0 generates trigger 0 (when the counter counts to a value equal to the VAL4 value) for the ADC with a delay of approximately $T_{deadtime}/2$. This delay ensures correct current sampling at the duty cycles close to 100 %.
- ADC starts the ADC conversation.
- When the ADC conversion is completed, the ADC ISR (ADC interrupt) is entered. The FOC calculation is done in this interrupt.

3.1.2 MC56F80xxx - Peripheral settings

All peripherals are configured using the MCUXpresso Config Tools. The MCUXpresso Config Tools set pins, clocks, and peripherals by generating corresponding sources (*pin_mux.c/h*, *clock_config.c/h*, *peripherals.c/h*, *freemaster_cfg.h*, and *Flash_config.h*). On MC56F80748, the eFlexPWM is used for 6-channel PWM generation. The 12-bit cyclic ADC is used for the phase currents and DC-bus voltage measurement. DC bus over-current protection is realized by an internal comparator (CMP). The PIT Timer is used for the slow interrupt generation. The peripherals are well described and depicted in the MCUXpresso Config Tools after opening *MC56F80748.mex*. For more information about the MCUXpresso Config Tools, see [MCUXpresso Config Tools](#).

3.2 CPU load and memory usage

The following information applies to the application built using the CodeWarrior v11.2 IDE in the Debug and Release configurations. The below tables show the memory usage and CPU load. The memory usage is calculated from the *.map* linker file, including the FreeMASTER recorder buffer allocated in RAM. The CPU load is measured using the

MCUXpresso SDK Field-Oriented Control (FOC) of 3-Phase PMSM and BLDC motors

QuadTimer, which is driven directly by the CPU clock. The CPU load is dependent on the fast-loop (FOC calculation) and slow-loop (speed loop) frequencies. In this case, it applies to the fast-loop frequency of 10 KHz and the slow-loop frequency of 1 KHz. The total CPU load is calculated using the following equations:

$$CPU_{fast} = cycles_{fast} \frac{f_{fast}}{f_{CPU}} 100 [\%]$$

$$CPU_{slow} = cycles_{slow} \frac{f_{slow}}{f_{CPU}} 100 [\%]$$

$$CPU_{total} = CPU_{fast} + CPU_{slow} [\%]$$

Where:

CPU_{fast} - the CPU load taken by the fast loop.

$cycles_{fast}$ - the number of cycles consumed by the fast loop.

f_{fast} - the frequency of the fast-loop calculation (10 KHz).

f_{CPU} - the CPU frequency.

CPU_{slow} - the CPU load taken by the slow loop.

$cycles_{slow}$ - the number of cycles consumed by the slow loop.

f_{slow} - the frequency of the slow-loop calculation (1 KHz).

CPU_{total} - the total CPU load consumed by the motor control.

Table 3. MC56F80748 CPU load and memory usage (SDM model)

Configuration	flash_sdm_lpm_debug	flash_sdm_lpm_release
Flash memory	44 540 B	29 500 B
RAM memory	7 952 B	5 648 B
Maximum CPU _{fast} load	40%	38%

Note: *flash_sdm_lpm_debug* and *flash_sdm_lpm_release* configurations feature FreeMASTER recorder which consumes **1024 B** of RAM and can be eliminated in the final code. The stack that consumes the RAM is **512 B** and it can be decreased in the final code. Several RTCESL functions are placed in RAM for speed optimization.

Table 4. MC56F80748 CPU load and memory usage (LDM model)

Configuration	flash_ldm_lpm_debug	flash_ldm_lpm_release
Flash memory	47 736 B	32 964 B
RAM usage	8 128 B	7 088 B
Maximum CPU _{fast} load	39%	37.5%

Note: *flash_ldm_lpm_debug* and *flash_ldm_lpm_release* configurations feature FreeMASTER recorder which consumes **1024 B** of FLASH and can be eliminated in the final code. The stack that consumes the RAM is **512 B** and it can be decreased in the final code. Several RTCESL functions are placed in RAM for speed optimization.

4 Project file and IDE workspace structure

All the necessary files are included in one package, which simplifies the distribution and decreases the size of the final package. The project contains four configurations (flash_ldm_lpm_debug, flash_ldm_lpm_release, flash_sdm_lpm_debug, flash_sdm_lpm_release) with different optimization levels and different data memory model (LDM - Large Data Memory model, SDM - Small Data Memory model). The folder structure in the unpacked package is different from the folder structure of the project cloned into a user's workspace. Most users clone the project using the MCUXpresso Config Tools into their workspace from the SDK package, so the folder structure of the cloned project is described below. The cloned project includes all the necessary files for the MCU operation, the motor-identification functions, the scalar and vector control of the motor, and the FreeMASTER MCAT project. This project serves for development and testing purposes.

4.1 PMSM project structure

The directory tree of a cloned PMSM project is shown in [Figure 7](#).

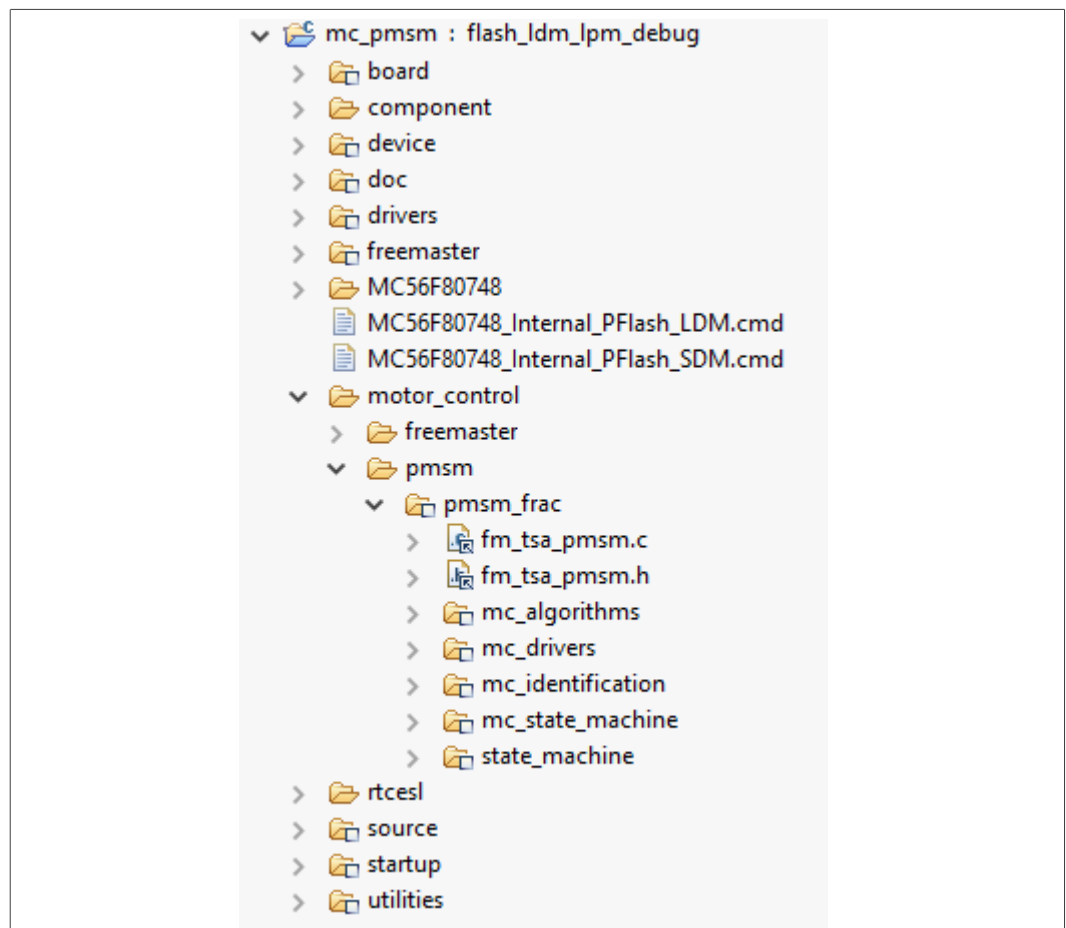

Figure 7. Directory tree

The main project folder contains the following folders and files:

- *.project* and *.cproject*—project files for CodeWarrior IDE.

- *board/board.c and .h*—contains the definitions and functions related to the board like LEDs and buttons.
- *board/clock_config.c and .h*—contains the MCU clock setup functions. These files are generated by the MCUXpresso Config Tools.
- *board/peripherals.c and .h*—contains the MCU peripherals' setup functions. These files are generated by the MCUXpresso Config Tools.
- *board/pin_mux.c and .h*—contains the MCU pins' setup functions. These files are generated by the MCUXpresso Config Tools.
- *device*—contains the MCU-related files like registers' definitions.
- *doc*—documentation folder.
- *drivers*—contains the necessary SDK drivers for MCU peripherals.
- *freemaster*—contains the FreeMASTER embedded part of code.
- *motor_control/pmsm/pmsm_frac*—folder containing common motor control code
 - *mc_algorithms*—contains the main control algorithms used to control the FOC and speed control loop.
 - *mc_drivers*—contains the source and header files used to initialize and run motor-control applications.
 - *mc_identification*—contains the source code for the automated parameter-identification routines of the motor.
 - *mc_state_machine*—contains the software routines that are executed when the application is in a particular state or state transition.
 - *fm_tsa_pmsm.c and .h*—TSA tables with variables used in FreeMASTER.
- *middleware/motor_control/freemaster*—contains the FreeMASTER *.pmp file and all MCAT-related files.
- *rtcesl*—Real-Time Control Embedded Software Libraries with elementary algorithms used to build the FOC.
- *source/freemaster_cfg.h*—FreeMASTER configuration file containing FreeMASTER communication and features setup. This file is generated by the MCUXpresso Config Tools.
- *source/m1_pmsm_appconfig.h*—contains the definitions of constants for the application control processes, parameters of the motor and controllers, and the constants for other vector control-related algorithms. When you tailor the application for a different motor using the Motor Control Application Tuning (MCAT) tool, this file is re-generated at the end of the tuning process.
- *source/main.c*—basic application initialization (enabling interrupts), subroutines for accessing the MCU peripherals, and interrupt service routines. The FreeMASTER communication is performed in the background infinite loop.
- *mc_periph_init.c and .h*—contains the motor-control peripheral drivers' initialization functions and macros for changing ADC channels assigned to the phase currents and board voltage. These files are specific for the board and MCU used.

5 Motor-control peripheral initialization

The motor-control peripherals are initialized by the MCUXpresso Config Tools. The motor-control drivers are initialized by calling the *MCDRV_Init_M1()* function during the MCU startup after the peripherals are configured. All motor-control drivers' initialization functions are in the *mc_periph_init.c* source file and the *mc_periph_init.h* header file. The definitions specified by the user are also in these files. The features provided by the functions are the 3-phase PWM generation and 3-phase current measurement, as well as the DC-bus voltage and auxiliary quantity measurement. The principles of both

MCUXpresso SDK Field-Oriented Control (FOC) of 3-Phase PMSM and BLDC motors

the 3-phase current measurement and the PWM generation using the Space Vector Modulation (SVM) technique are described in *Sensorless PMSM Field-Oriented Control* (document [DRM148](#)).

The `mc_periph_init.h` header file provides several macros that can be defined by the user:

- `M1_PWM_FREQ`—the value of this definition must correspond to the actual PWM frequency.
- `M1_FOC_FREQ_VS_PWM_FREQ`—enables the user to call the fast loop interrupt at every first, second, third, or n^{th} PWM reload. This feature is not supported on DSCs and this macro must be kept at 1.
- `M1_PWM_DEADTIME`—the value of the PWM dead time in nanoseconds must correspond to the actual dead time setting in eFlexPWM module.
- `M1_SLOW_LOOP_FREQ`—the value of this definition must correspond to the actual speed-loop frequency.
- `M1_PWM_PAIR_PH[A..C]`—these macros enable a simple assignment of the physical motor phases to the PWM periphery channels (or submodules). Change the order of the motor phases this way.
- `M1_BRAKE_SET`, `M1_BRAKE_CLEAR`—DCbus braking resistor control macros (GPIO control).
- `M1_FAULT_NUM`—PWM fault number must correspond to fault number initialized in PWM fault register.
- `M1_ADC[0,1]_PH[A..C]`—these macros are used to assign the ADC channels for the phase current measurement. The general rule is that at least one of the phase currents must be measurable on both ADC converters and the two remaining phase currents must be measurable on different ADC converters. The reason for this is that the selection of the phase current pair to measure depends on the current SVM sector. If this rule is broken, a preprocessor error is issued. For more information about the 3-phase current measurement, see *Sensorless PMSM Field-Oriented Control* (document [DRM148](#)).
- `M1_ADC[0,1]_UDCB`—this define is used to select the ADC channel for the measurement of the DC-bus voltage.

In the motor-control software, these API-serving ADC and PWM peripherals are available:

- The available APIs for the ADC are:
 - `bool_t M1_MCDRV_ADC_GET(mcdrv_adc_t*)`—this function reads and calculates the actual values of the 3-phase currents, DC-bus voltage, and auxiliary quantity. This function always returns true.
 - `bool_t M1_MCDRV_CURR_3PH_CHAN_ASSIGN(mcdrv_adc_t*)`—calling this function assigns proper ADC channels for the next 3-phase current measurement based on the SVM sector. The function always returns true.
 - `bool_t M1_MCDRV_CURR_3PH_CALIB_INIT(mcdrv_adc_t*)`—this function initializes the phase-current channel-offset measurement. This function always returns true.
 - `bool_t M1_MCDRV_CURR_3PH_CALIB(mcdrv_adc_t*)`—this function reads the current information from the unpowered phases of a stand-still motor and filters them using moving average filters. The goal is to obtain the value of the measurement offset. The length of the window for moving the average filters is set to eight samples by default. This function always returns true.
 - `bool_t M1_MCDRV_CURR_3PH_CALIB_SET(mcdrv_adc_t*)`—this function asserts the phase-current measurement offset values to the internal registers. Call this

function after a sufficient number of `M1_MCDRV_CURR_3PH_CALIB()` calls. This function always returns true.

- The available APIs for the PWM are:
 - `bool_t M1_MCDRV_PWM3PH_SET(mcdrv_pwma_pwm3ph_t*)`—this function updates the PWM phase duty cycles. This function always returns true.
 - `bool_t M1_MCDRV_PWM3PH_EN(mcdrv_pwma_pwm3ph_t*)`—calling this function enables all PWM channels. This function always returns true.
 - `bool_t M1_MCDRV_PWM3PH_DIS(mcdrv_pwma_pwm3ph_t*)`—calling this function disables all PWM channels. This function always returns true.
 - `bool_t M1_MCDRV_PWM3PH_FLT_GET(mcdrv_pwma_pwm3ph_t*)`—this function returns the state of the over-current fault flags and automatically clears the flags (if set). This function returns true when an over-current event occurs. Otherwise, it returns false.

6 User interface

The application contains the demo mode to demonstrate motor rotation. You can operate it using a button on the board or via FreeMASTER. The FreeMASTER application consists of two parts: the PC application used for variable visualization and the set of software drivers running in the embedded application. Data is transferred between the PC and the embedded application via the serial interface. This interface is provided by the debugger or the virtual serial port circuit included in the boards.

The application can be controlled using these two interfaces:

- The user's button on the development board (controlling the demo mode). See `pin_mux.c/h` which button is configured for this function.
- Remote control using FreeMASTER (chapter [Section 7](#)):
 - Using the Motor Control Application Tuning (MCAT) interface in the “Control Structure” tab or the “Application control” tab (controlling the demo mode).
 - Setting a variable in the FreeMASTER Variable Watch.

If you are using your own motor (different from the default motors), make sure to identify all motor parameters. The automated parameter identification is described in the following sections.

7 Remote control using FreeMASTER

This section provides information about the tools and recommended procedures to control the sensorless PMSM Field-Oriented Control (FOC) application using FreeMASTER. The application contains the embedded-side driver of the FreeMASTER real-time debug monitor and data visualization tool for communication with the PC. It supports non-intrusive monitoring, as well as the modification of target variables in real time, which is very useful for the algorithm tuning. Besides the target-side driver, the FreeMASTER tool requires the installation of the PC application as well. You can download FreeMASTER 3.x at www.nxp.com/freemaster. To run the FreeMASTER application including the MCAT tool, double-click the `pmsm_frac_dsc.pmp` file located in the `middleware/motor_control/freemaster` depicted in [Figure 7](#). The FreeMASTER application starts and the environment is created automatically, as defined in the `*.pmp` file.

7.1 Establishing FreeMASTER communication

The remote operation is provided by FreeMASTER via the USB interface. Perform the following steps to control a PMSM motor using FreeMASTER:

1. Download the project from the CodeWarrior IDE to the MCU and run it. It is J12 on MC56F80000-EVK, J26 on MC56F81000-EVK, J14 on MC56F83000-EVK, J18 on TWR-MC56F8200 and J18 on TWR-MC56F8400 to connect with the PC. Be sure to install the CP210x USB to UART bridge driver on the PC before the connection.
2. Open the FreeMASTER file *pmsm_frac_dsc.pmp*. The PMSM project usually uses the TSA by default. However, at SDM configurations or at MCUs with insufficient memory the TSA feature is not enabled. Then it is necessary to select an ELF manually: Go to *Project* → *Options* → *MAP Files* → *Default Symbol File* and browse for corresponding *mc_pmsm_xxxx.elf* located in the *build* folder of your CodeWarrior project.
3. Click the communication button (the green “GO” button in the top left-hand corner) to establish the communication. It may take couple of seconds to establish the connection, depending on the size of the TSA table.

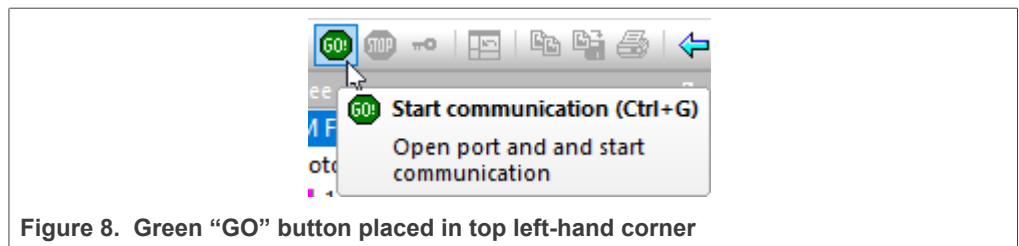

Figure 8. Green “GO” button placed in top left-hand corner

4. If the communication is established successfully, the FreeMASTER communication status in the bottom right-hand corner changes from “Not connected” to “RS232 UART Communication; COMxx; speed=115200”. Otherwise, the FreeMASTER warning popup window appears.



Figure 9. FreeMASTER—communication is established successfully

5. Press *F5* to reload the MCAT HTML page and check the App ID.
6. Control the PMSM motor using the MCAT “Control structure” tab, the MCAT “Application demo control” tab, or by directly writing to a variable in a variable watch.
7. If you rebuild and download the new code to the target, turn the FreeMASTER application off and on.

If the communication is not established successfully, perform the following steps:

1. Go to the “Project -> Options -> Comm” tab and make sure that the correct COM port is selected and the communication speed is set to 115200 bps.

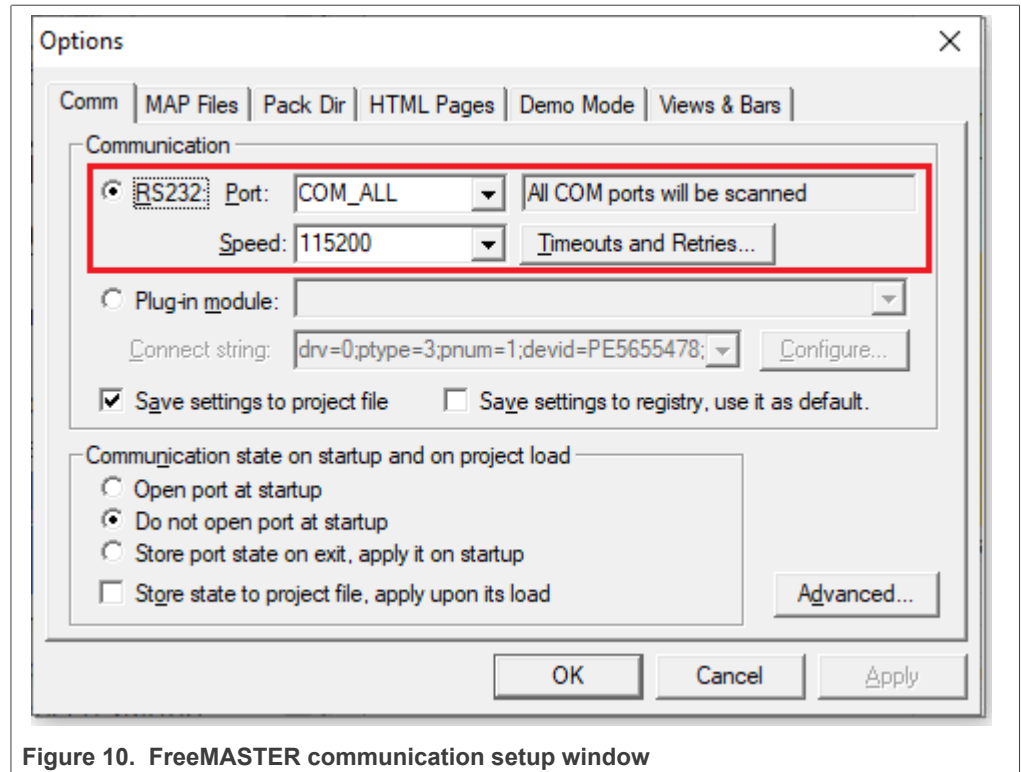

Figure 10. FreeMASTER communication setup window

2. If “Silicon Labs CP210x USB to UART Bridge” is not printed out in the message box next to the “Port” drop-down menu, unplug and then plug in the USB cable and reopen the FreeMASTER project.
3. Try to use another USB on the development board and repeat [1. - 6. step.](#)

Make sure to supply your development board from a sufficient energy source. Sometimes the PC USB port is not sufficient to supply the development board.

7.2 MCAT FreeMASTER interface (Motor Control Application Tuning)

The PMSM sensor/sensorless FOC application can be easily controlled and tuned using the Motor Control Application Tuning (MCAT) plug-in for PMSM. The MCAT for PMSM is a user-friendly modular page, which runs within FreeMASTER. The tool consists of the tab menu, tuning mode selector, and workspace shown in [Figure 11](#). Each tab from the tab menu represents one sub-module which enables you to tune or control different aspects of the application. Besides the MCAT page for PMSM, several scopes, recorders, and variables in the project tree are predefined in the FreeMASTER project file to further simplify the motor parameter tuning and debugging. When the FreeMASTER is not connected to the target, the “App ID” line shows “offline”. When the communication with the target MCU is established using a correct software, the “App ID” line displays the board name “pmsm_used_board” and all stored parameters for the given MCU are loaded. If the connection is established and the board ID is not shown, press *F5* to reload the MCAT HTML page.

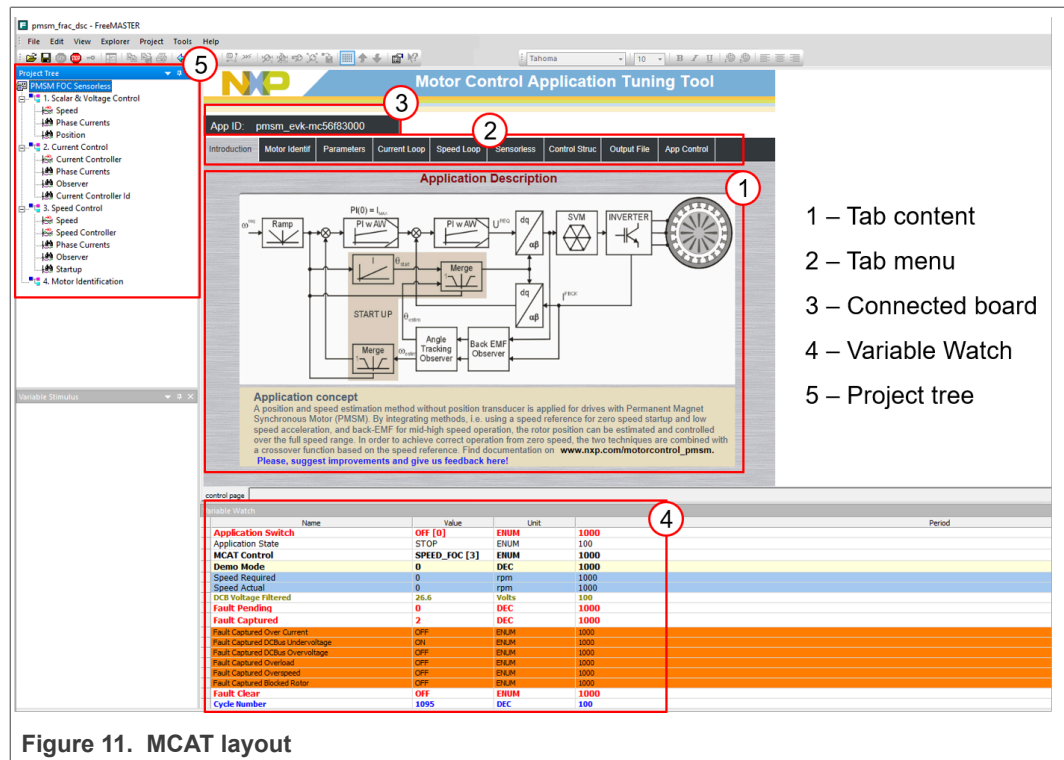

Figure 11. MCAT layout

In the default configuration, the following tabs are available:

- “Introduction”—welcome page with the PMSM sensor/sensorless FOC diagram and a short description of the application.
- “Motor Identif”—PMSM semi-automated parameter measurement control page. The PMSM parameter identification is more closely described further on in this document.
- “Parameters”—this page enables you to modify the motor parameters, specification of hardware and application scales, alignment, and fault limits.
- “Current Loop”—current loop PI controller gains and output limits.
- “Speed Loop”—this tab contains fields for the specification of the speed controller proportional and integral gains, as well as the output limits and parameters of the speed ramp.
- “Sensorless”—this page enables you to tune the parameters of the BEMF observer, tracking observer, and open-loop startup.
- “Control Struc”—this application control page enables you to select and control the PMSM using different techniques (scalar—Volt/Hertz control, voltage FOC, current FOC and speed FOC). The application state is also shown in this tab.
- “Output file”—this tab shows all the calculated constants that are required by the PMSM sensorless FOC application. It is also possible to generate the *m1_pmsm_appconfig.h* file, which is then used to preset all application parameters permanently at the project rebuild.
- “App Control”—this tab contains the graphical elements like the speed gauge, DC-bus voltage measurement bar, and variety of switches which enable a simple, quick, and user-friendly application control. The fault clearing and the demo mode (which sets various predefined required speeds over time) can be also controlled from here.

Most tabs offer the possibility to immediately load the parameters specified in the MCAT into the target using the “Update target” button and save (or restore) them from the hard drive file using the “Reload Data” and “Store Data” buttons.

The following sections provide simple instructions on how to identify the parameters of a connected PMSM motor and how to appropriately tune the application.

7.2.1 Control structure—“Control Struc” tab

The application can be controlled through the “Control Struc” tab, which is shown in [Figure 12](#). The state control area on the left side of the screen shows the current application state and enables you to turn the main application switch on or off (turning a running application off disables all PWM outputs). The “Cascade Control Structure” area is placed in the right-hand side of the screen. Here you can choose between the scalar control and the FOC control using the appropriate buttons. The selected parts of the FOC cascade structure can be enabled by selecting “Voltage FOC”, “Current FOC”, and “Speed FOC”. This is useful for application tuning and debugging.

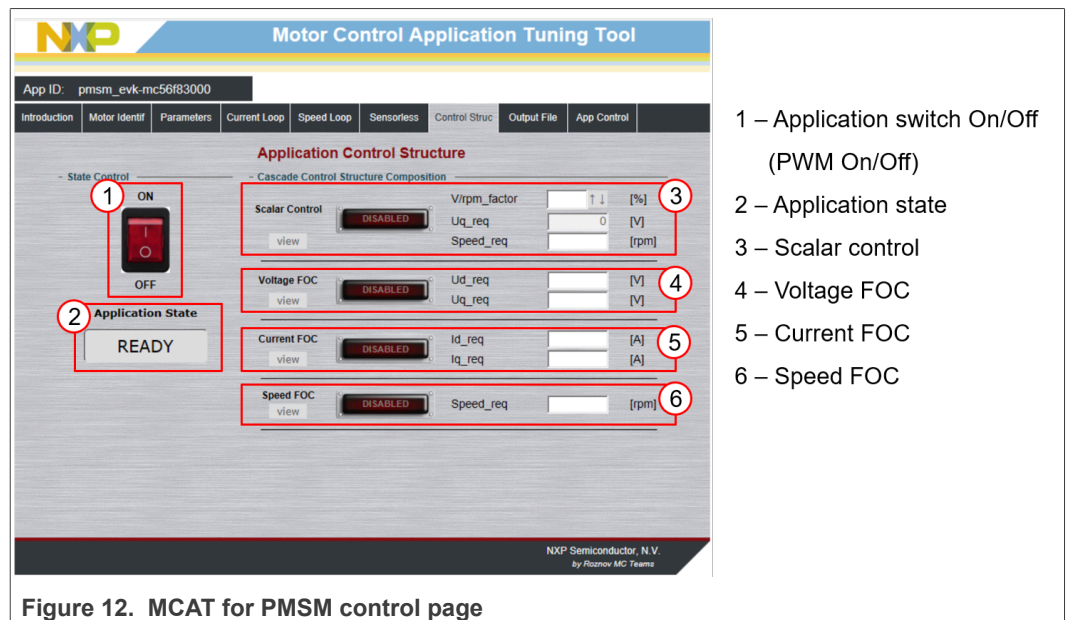

Figure 12. MCAT for PMSM control page

The scalar control diagram is shown in [Figure 13](#). It is the simplest type of motor-control techniques. The ratio between the magnitude of the stator voltage and the frequency must be kept at the nominal value. Hence, the control method is sometimes called Volt per Hertz (or V/Hz). The position estimation BEMF observer and tracking observer algorithms (see [Sensorless PMSM Field-Oriented Control \(document DRM148\)](#) for more information) run in the background, even if the estimated position information is not directly used. This is useful for the BEMF observer tuning.

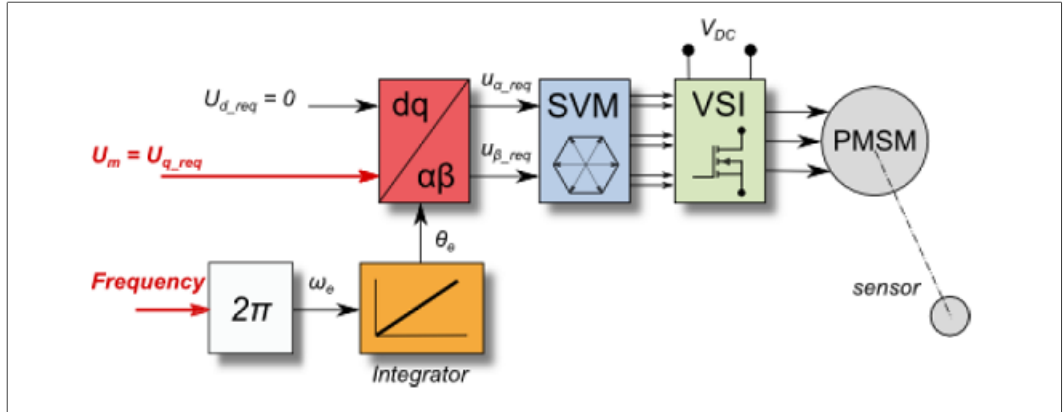

Figure 13. Scalar control mode

The block diagram of the voltage FOC is in [Figure 14](#). Unlike the scalar control, the position feedback is closed using the BEMF observer and the stator voltage magnitude is not dependent on the motor speed. Both the d-axis and q-axis stator voltages can be specified in the “Ud_req” and “Uq_req” fields. This control method is useful for the BEMF observer functionality check.

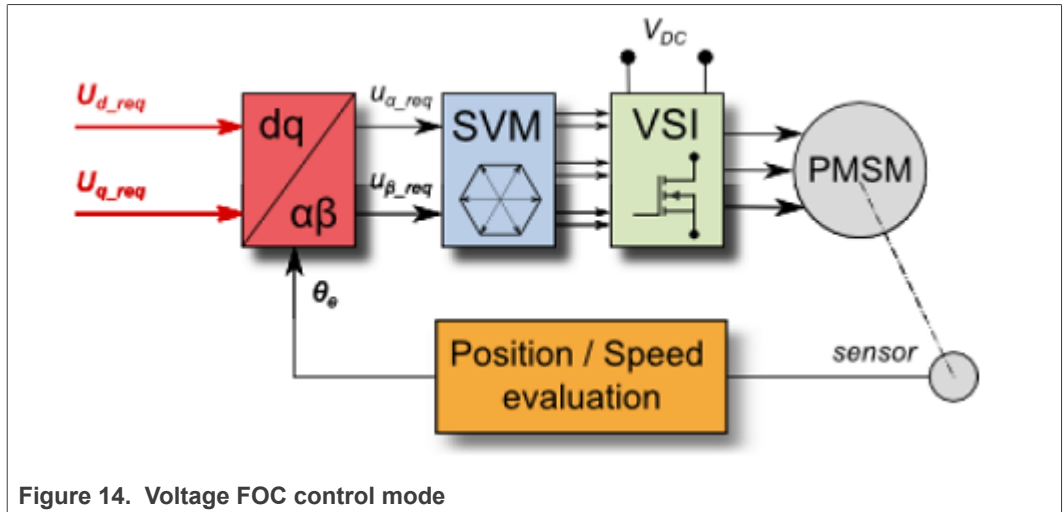

Figure 14. Voltage FOC control mode

The current FOC (or torque) control requires the rotor position feedback and the currents transformed into a d-q reference frame. There are two reference variables (“Id_req” and “Iq_req”) available for the motor control, as shown in the block diagram in [Figure 15](#). The d-axis current component “isd_req” is responsible for the rotor flux control. The q-axis current component of the current “isq_req” generates torque and, by its application, the motor starts running. By changing the polarity of the current “isq_req”, the motor changes the direction of rotation. Supposing that the BEMF observer is tuned correctly, the current PI controllers can be tuned using the current FOC control structure.

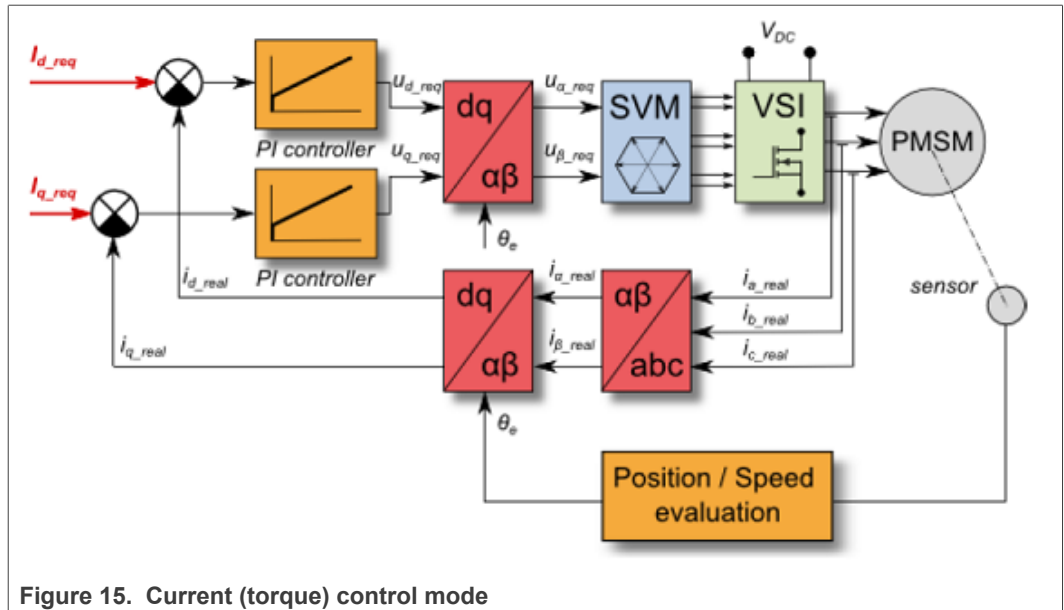

Figure 15. Current (torque) control mode

The speed PMSM sensor/sensorless FOC (its diagram is shown in [Figure 16](#)) is activated by enabling the speed FOC control structure. Enter the required speed into the “Speed_req” field. The d-axis current reference is held at 0 during the entire FOC operation.

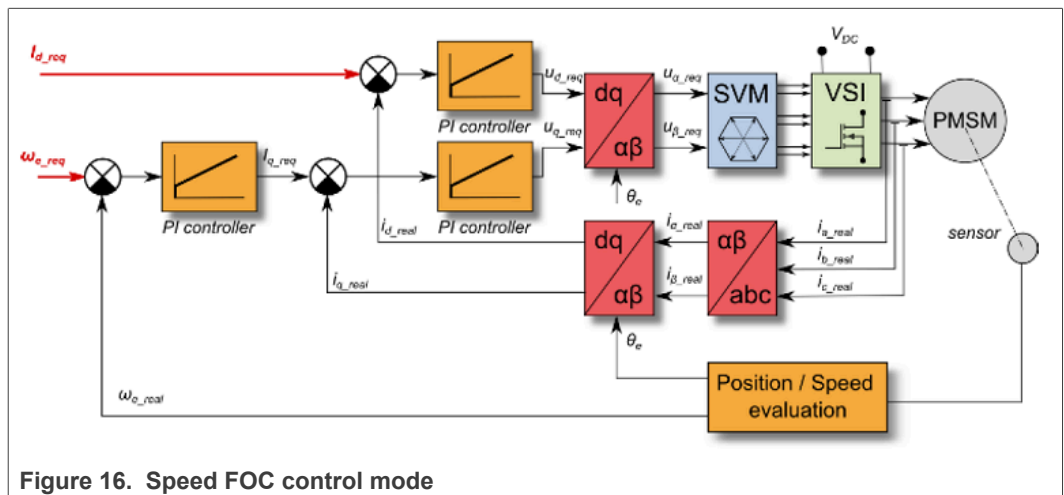

Figure 16. Speed FOC control mode

7.2.2 Application demo control—“App control” tab

After launching the application and performing all necessary settings, you can control the PMSM motor using the FreeMASTER application demo control page. This page contains:

- Speed gauge—shows the actual and required speeds.
- Required speed slider—sets up the required speed.
- DC-bus voltage—shows the actual DC-bus voltage.
- Current i_q —shows the actual torque-producing current.
- Current limitation—sets up the torque-producing current limit.
- Demo mode on/off button—turns the demonstration mode on/off.
- RUN/STOP PWM button—runs/stops the whole application (sets the PWM on and off).

- Notification—shows the notification about the actual application state (or faults).

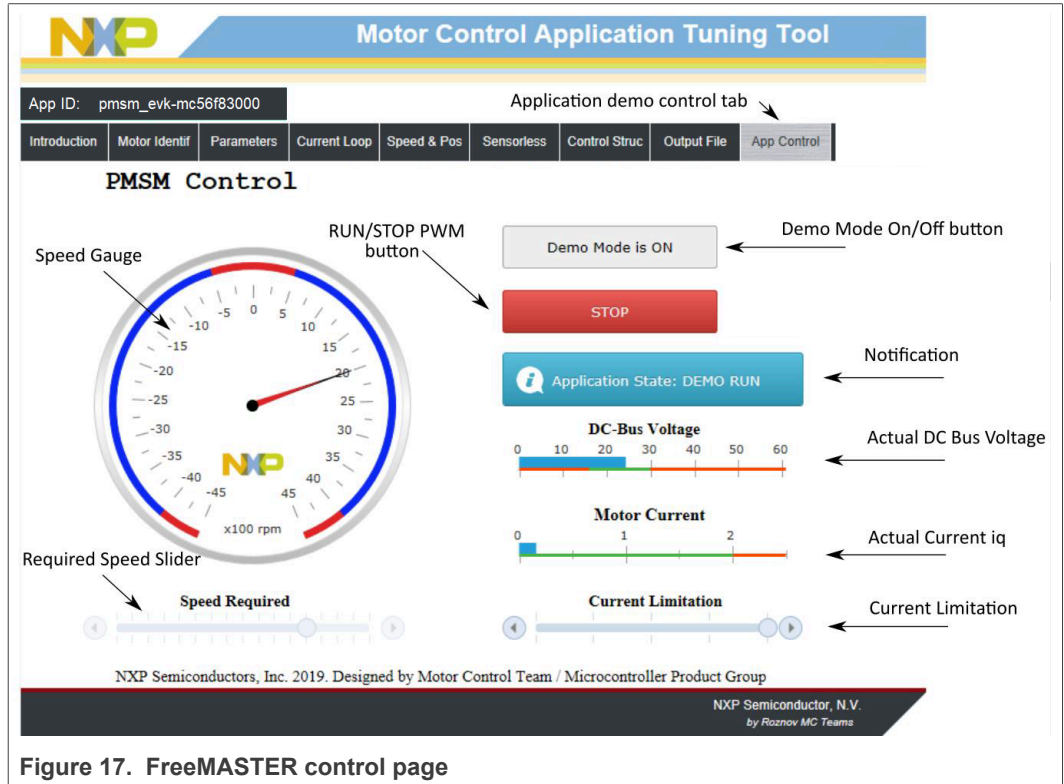

Figure 17. FreeMASTER control page

The following are the basic instructions for controlling a motor:

- To start the motor, set the required speed using the speed slider.
- In case of a fault, click on the fault notification to clear the fault.
- Click the “Demo Mode On/Off” button to turn the demonstration mode on/off.
- Click the “RUN/STOP” button to stop the motor.

8 Identifying parameters of user motor using MCAT

This section provides a guide on how to run your own motor or tune the default motor in several steps. It is highly recommended to go through all the steps carefully to eliminate any possible issues during the tuning process. The state diagram in [Figure 18](#) shows a typical PMSM sensor/sensorless control tuning process.

Because the model-based control methods of the PMSM drives are the most effective and usable, obtaining an accurate model of a motor is an important part of the drive design and control. For the implemented FOC algorithms, it is necessary to know the value of the stator resistance R_s , direct inductance L_d , quadrature inductance L_q , and BEMF constant K_e . If your connected PMSM motor is not the default Teknic or Linix motor described in the previous sections, identify the parameters of your motor first. Each tuning phase is described in more detail in the following sections.

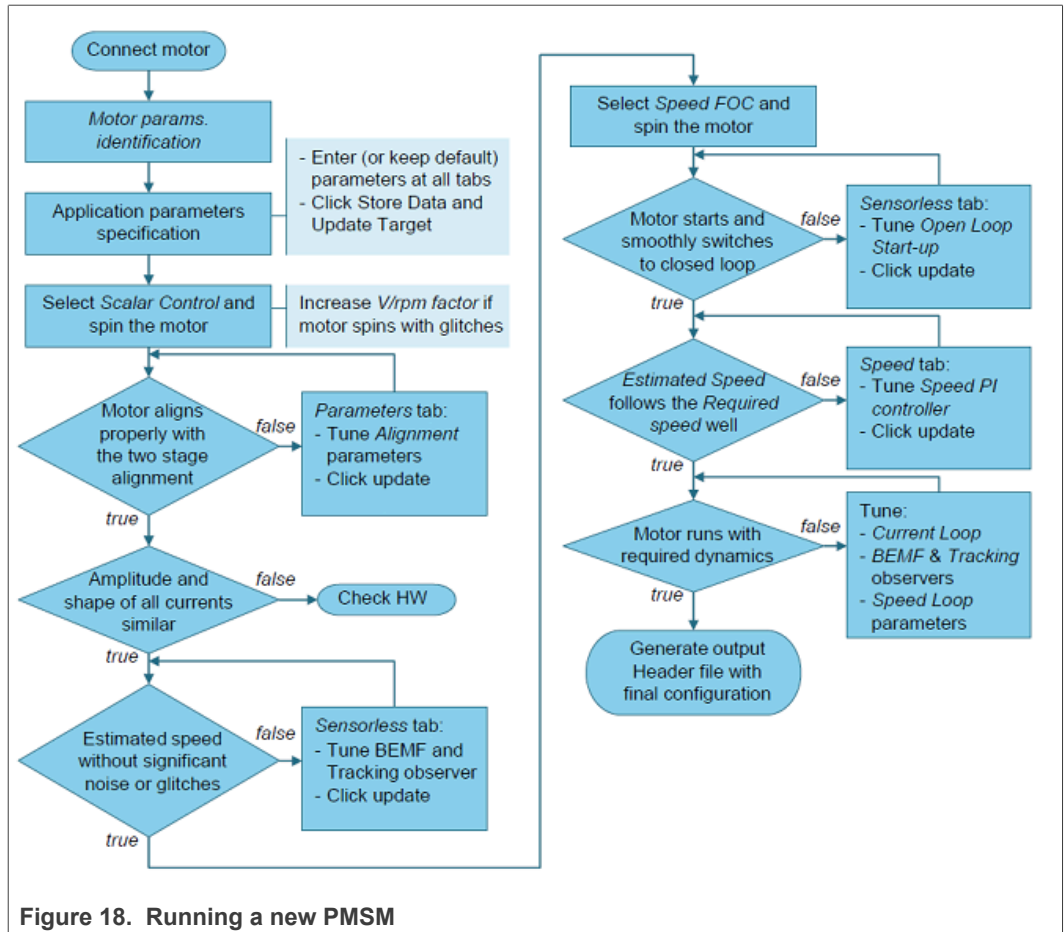

Figure 18. Running a new PMSM

8.1 Power stage characterization

Each inverter introduces the total error voltage U_{error} , which is caused by the dead time, current clamping effect, and transistor voltage drop. The total error voltage U_{error} depends on the phase current i_s and this dependency is measured during the power stage characterization process. An example of the inverter error characteristic is shown in Figure 19. The power stage characterization is a part of the MCAT and it can be controlled from the “Motor Identif” tab. To perform the characterization, connect the motor with a known stator resistance R_s and enter this value into the “Calib R_s ” field. Then specify the “Calibration Range”, which is the range of the stator current i_s , in which the measurement of U_{error} is performed. Start the characterization by pressing the “Calibrate” button. The characterization gradually performs 65 i_{sd} current steps (from $i_s = -I_{s,calib}$ to $i_s = I_{s,calib}$) with each taking 300 ms, so be aware that the process takes about 20 seconds and the motor must withstand this load. The acquired characterization data is saved to a file and used later for the phase voltage correction during the R_s measurement process. The following R_s measurement can be done with the $I_{s,calib}$ maximum current. It is recommended to use a motor with a low R_s for characterization purposes.

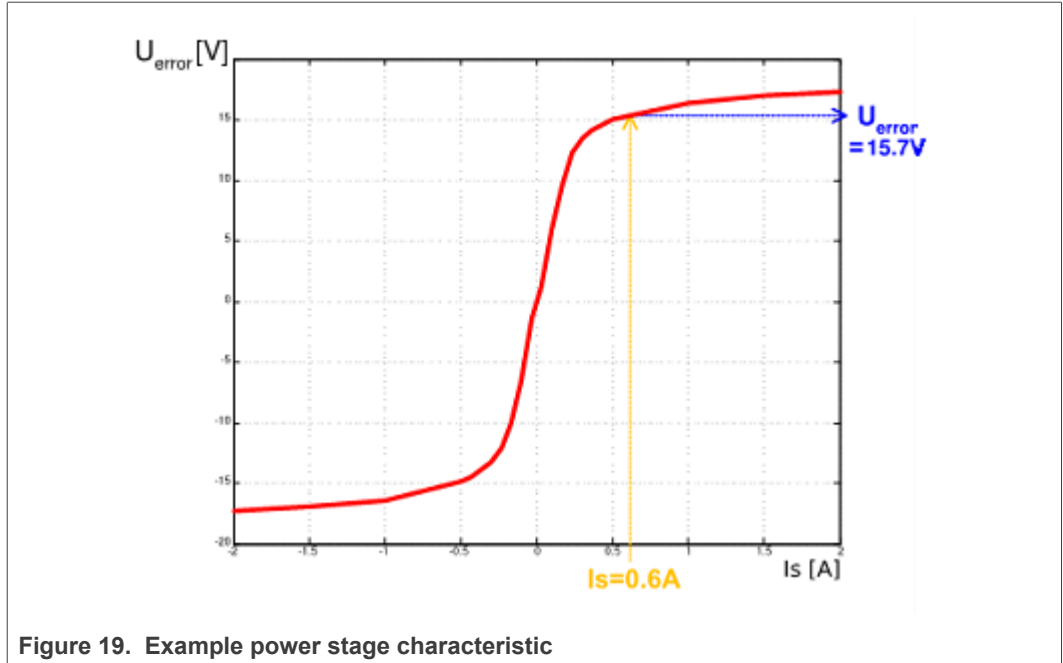

Figure 19. Example power stage characteristic

The power stage characterization is necessary only for the user hardware board. When the NXP power stages (TWR, FRDM, or HVP) are used with the application, the characterization process can be omitted. The acquired characterization data is saved into a file, so it is necessary to do it only once for a given hardware.

8.2 Stator resistance measurement

The stator resistance R_s is measured using the DC current I_{phN} value, which is applied to the motor for 1200 ms. The DC voltage U_{DC} is held using current controllers. Their parameters are selected conservatively to ensure stability. The stator resistance R_s is calculated using the Ohm's law as:

$$R_s = \frac{U_{DC} - U_{error}}{I_{phN}} \text{ [}\Omega\text{]}$$

8.3 Stator inductance

For the stator inductance (L_s) identification purposes, a sinusoidal measurement voltage is applied to the motor. During the L_s measurement, the voltage control is enabled. The frequency and amplitude of the sinusoidal voltage are obtained before the actual measurement, during the tuning process. The tuning process begins with a 0-V amplitude and the F_{start} frequency, which are applied to the motor. The amplitude is gradually increased by $U_{d inc}$ up to a half of the DC-bus voltage ($DC_{bus}/2$), until $I_{d ampl}$ is reached. If $I_{d ampl}$ is not reached even with the $DC_{bus}/2$ and F_{start} , the frequency of the measuring signal is gradually decreased by F_{dec} down to F_{min} again, until $I_{d ampl}$ is reached. If $I_{d ampl}$ is still not reached, the measurement continues with $DC_{bus}/2$ and F_{min} . The tuning process is shown in [Figure 20](#).

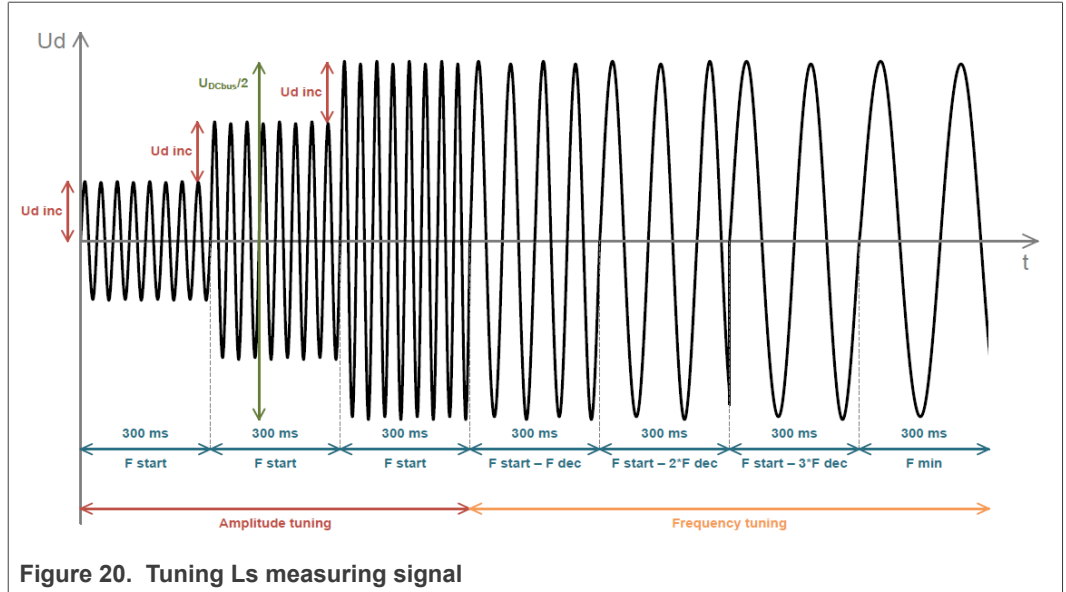

When the tuning process is complete, the sinusoidal measurement signal (with the amplitude and frequency obtained during the tuning process) is applied to the motor. The total impedance of the RL circuit is then calculated from the voltage and current amplitudes and L_S is calculated from the total impedance of the RL circuit.

$$Z_{RL} = \frac{U_d}{I_d \text{ ampl}} [\Omega]$$

$$X_{Ls} = \sqrt{Z_{RL}^2 - R_s^2} [\Omega]$$

$$L_s = \frac{X_{Ls}}{2\pi f} [\Omega]$$

The direct inductance L_d and quadrature inductance L_q measurements are made in the same way as L_S . Before the L_d and L_q measurement is made, DC current is applied to the D-axis, which aligns the rotor. For the L_d measurement, the sinusoidal voltage is applied in the D-axis. For the L_q measurement, the sinusoidal voltage is applied in the Q-axis.

8.4 BEMF constant measurement

Before the actual BEMF constant (K_e) measurement, the MCAT tool calculates the current controllers and BEMF observer constants from the previously measured R_s , L_d , and L_q . To measure K_e , the motor must spin. I_d is controlled through $I_d \text{ meas}$ and the electrical open-loop position is generated by integrating the required speed, which is derived from N_{nom} . When the motor reaches the required speed, the BEMF voltages obtained by the BEMF observer are filtered and K_e is calculated:

$$K_e = \frac{U_{BEMF}}{\omega_{el}} [\Omega]$$

When K_e is being measured, you have to visually check to determine whether the motor is spinning properly. If the motor is not spinning properly, perform these steps:

- Ensure that the number of pp is correct. The required speed for the K_e measurement is also calculated from pp . Therefore, inaccuracy in pp causes inaccuracy in the resulting K_e .
- Increase $I_{d\,meas}$ to produce higher torque when spinning during the open loop.
- Decrease N_{nom} to decrease the required speed for the K_e measurement.

8.5 Number of pole-pair assistant

The number of pole-pairs cannot be measured without a position sensor. However, there is a simple assistant to determine the number of pole-pairs (pp). The number of the pp assistant performs one electrical revolution, stops for a few seconds, and then repeats it. Because the pp value is the ratio between the electrical and mechanical speeds, it can be determined as the number of stops per one mechanical revolution. It is recommended not to count the stops during the first mechanical revolution because the alignment occurs during the first revolution and affects the number of stops. During the pp measurement, the current loop is enabled and the I_d current is controlled to $I_{d\,meas}$. The electrical position is generated by integrating the open-loop speed. If the rotor does not move after the start of the number of pp assistant, stop the assistant, increase $I_{d\,meas}$, and restart the assistant.

8.6 PMSM electrical and parameters measurement process

If the parameters of your own motor are known from the datasheet, you can enter them in the "Parameters" tab. If you don't know the parameters of your motor, you have to use automatic parameter identification.

The motor identification process can be controlled and set up in the MCAT "Motor Identif" tab, which is shown in [Figure 21](#). To measure your own motor, follow these steps:

- Select your hardware board. Choose between the standard NXP hardware or use your own. If you use your own hardware, specify its scales ("I max" and "U DCB max" in the "Parameters" menu tab).
- If you don't know the number of motor's pole-pairs, use the number of pole-pair assistant and compute the number of motor rotor stops in one turn.
- If you use your own hardware for the first time (other than NXP boards), perform the power stage characterization.
- Enter the motor measurement parameters and start the measurement by pressing the "Measure electrical" button. You can observe which parameter is being measured in the "Status" bar.

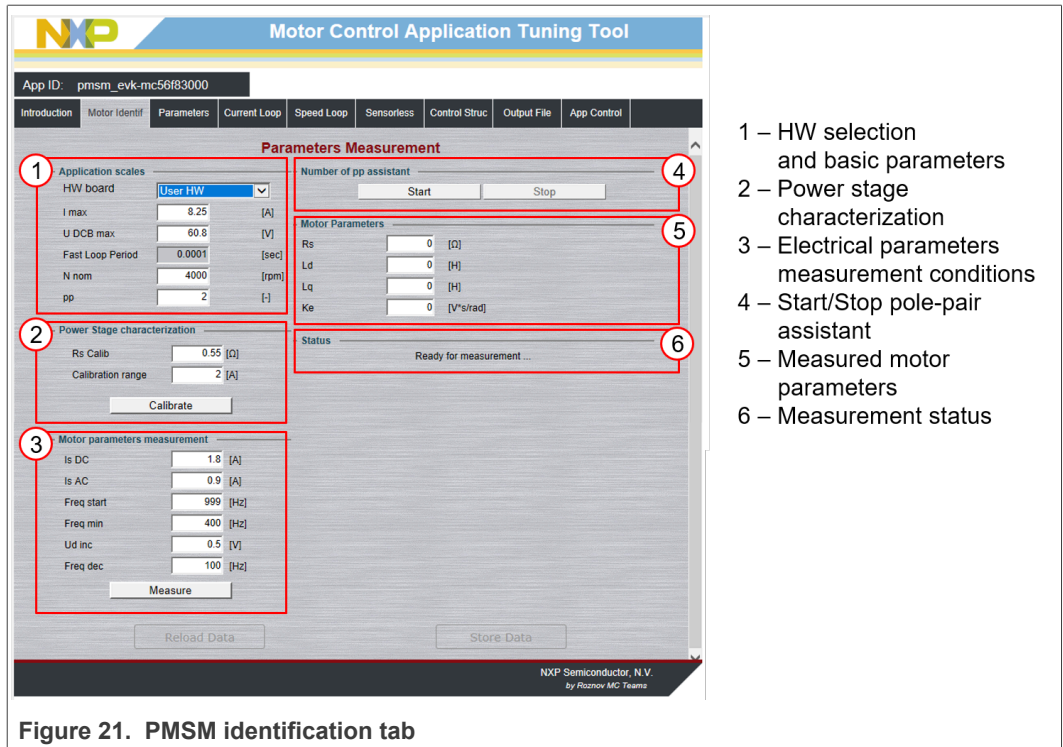

Figure 21. PMSM identification tab

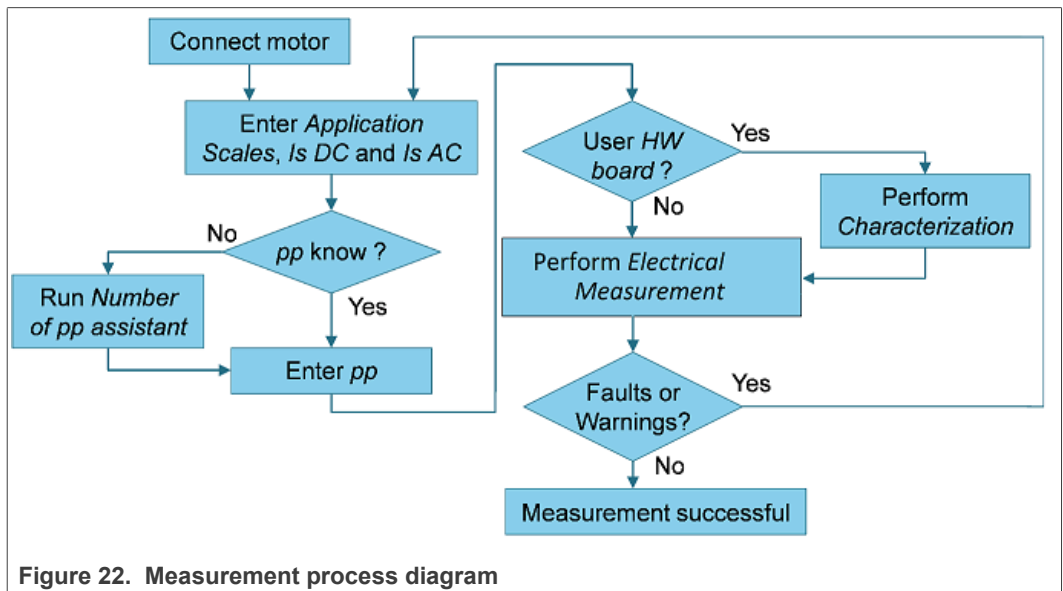

Figure 22. Measurement process diagram

During the measurement, faults and warnings may occur. Do not confuse these faults for the application faults, such as overcurrent, undervoltage, and so on. The list of these faults with their description and possible troubleshooting is shown in [Figure 22](#).

Table 5. Measurement faults and warnings

Fault no.	Fault description	Fault reason	Troubleshooting
1	Motor not connected	$I_d > 50$ mA cannot be reached with the available DC-bus voltage.	Check that the motor is connected.
2	R_s too high for calibration	The calibration cannot be reached with the available DC-bus voltage.	Use a motor with a lower R_s for the power stage characterization.
3	Current measurement I_s DC not reached	The user-defined I_s DC was not reached, so the measurement was taken with a lower I_s DC.	Raise the DC-bus voltage to reach the I_s DC or lower the I_s DC to avoid this warning.
4	Current amplitude measurement I_s AC not reached	The user-defined I_s AC was not reached, so the measurement was taken with a lower I_s AC.	Raise the DC-bus voltage or lower the F_{min} to reach the I_s AC or lower the I_s AC to avoid this warning.
5	Wrong characteristic data	The characteristic data, which is used for the voltage correction, does not correspond to the actual power stage.	Select the user hardware and perform the calibration.

8.7 Initial configuration setting and update

1. Open the PMSM control application FreeMASTER project containing the dedicated MCAT plug-in module.
2. Select the "Parameters" tab.
3. Leave the measured motor parameters or specify the parameters manually.
The motor parameters can be obtained from the motor data sheet or using the PMSM parameters measurement procedure described in *PMSM Electrical Parameters Measurement* (document [AN4680](#)). All parameters provided in [Table 6](#) are accessible. The motor inertia J expresses the overall system inertia and can be obtained using a mechanical measurement. The J parameter is used to calculate the speed controller constant. However, the manual controller tuning can also be used to calculate this constant.

Table 6. MCAT motor parameters

Parameter	Units	Description	Typical range
pp	[-]	Motor pole pairs	1-10
R_s	[Ω]	1-phase stator resistance	0.3-50
L_d	[H]	1-phase direct inductance	0.00001-0.1
L_q	[H]	1-phase quadrature inductance	0.00001-0.1
K_e	[V.sec/rad]	BEMF constant	0.001-1
J	[kg.m ²]	System inertia	0.00001-0.1
$I_{ph\ nom}$	[A]	Motor nominal phase current	0.5-8
$U_{ph\ nom}$	[V]	Motor nominal phase voltage	10-300

Table 6. MCAT motor parameters...continued

Parameter	Units	Description	Typical range
N nom	[rpm]	Motor nominal speed	1000-2000

- Set the hardware scales—the modification of these two fields is not required when a reference to the standard power stage board is used. These scales express the maximum measurable current and voltage analog quantities.
- Check the fault limits—these fields are not accessible in the “Basic” mode and are calculated using the motor parameters and hardware scales (see [Table 7](#)).

Table 7. Fault limits

Parameter	Units	Description	Typical range
U DCB trip	[V]	Voltage value at which the external braking resistor switch turns on	U DCB Over ~ U DCB max
U DCB under	[V]	Trigger value at which the undervoltage fault is detected	0 ~ U DCB Over
U DCB over	[V]	Trigger value at which the overvoltage fault is detected	U DCB Under ~ U max
N over	[rpm]	Trigger value at which the overspeed fault is detected	N nom ~ N max
N min	[rpm]	Minimal actual speed value for the sensorless control	(0.05~0.2) *N max

- Check the application scales—these fields are not accessible in the “Basic” mode and are calculated using the motor parameters and hardware scales.

Table 8. Application scales

Parameter	Units	Description	Typical range
N max	[rpm]	Speed scale	>1.1 * N nom
E max	[V]	BEMF scale	ke* Nmax
kt	[Nm/A]	Motor torque constant	-

- Check the alignment parameters— The parameters express the required voltage value applied to the motor during the rotor alignment and its duration.
- Click the “Store Data” button to save the modified parameters into the inner file.

8.8 Control structure modes

- Select the scalar control by clicking the “DISABLED” button in the “Scalar Control” section. The button color changes to red and the text changes to “ENABLED”.
- Turn the application switch on. The application state changes to “RUN”.
- Set the required frequency value in the “Freq_req” field; for example, 15 Hz in the “Scalar Control” section. The motor starts running ([Figure 23](#)).

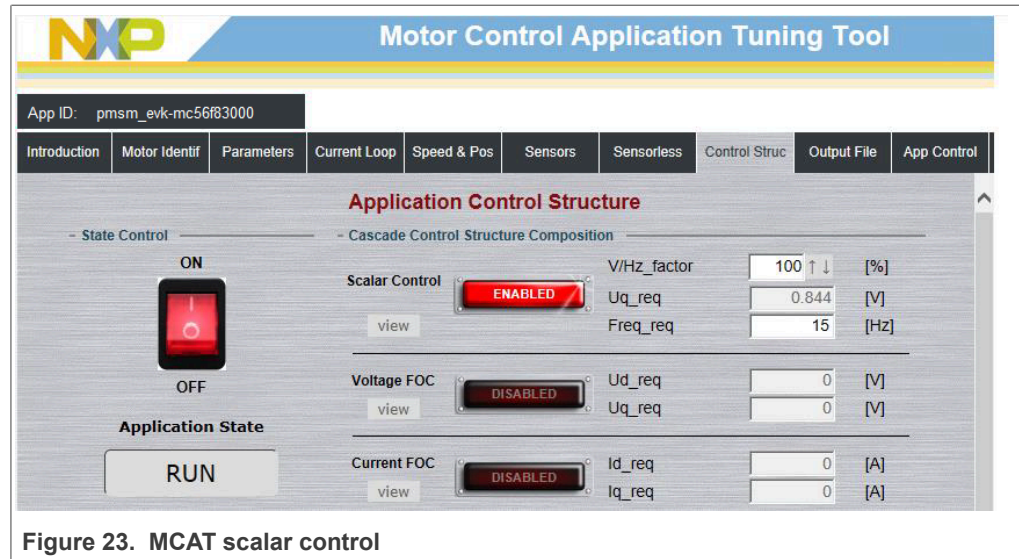

Figure 23. MCAT scalar control

4. Select the “Phase Currents” recorder from the “Scalar & Voltage Control” FreeMASTER project tree.
5. The optimal ratio for the V/Hz profile can be found by changing the V/Hz factor directly or using the “UP/DOWN” buttons. The shape of the motor currents should be close to a sinusoidal shape ([Figure 24](#)).

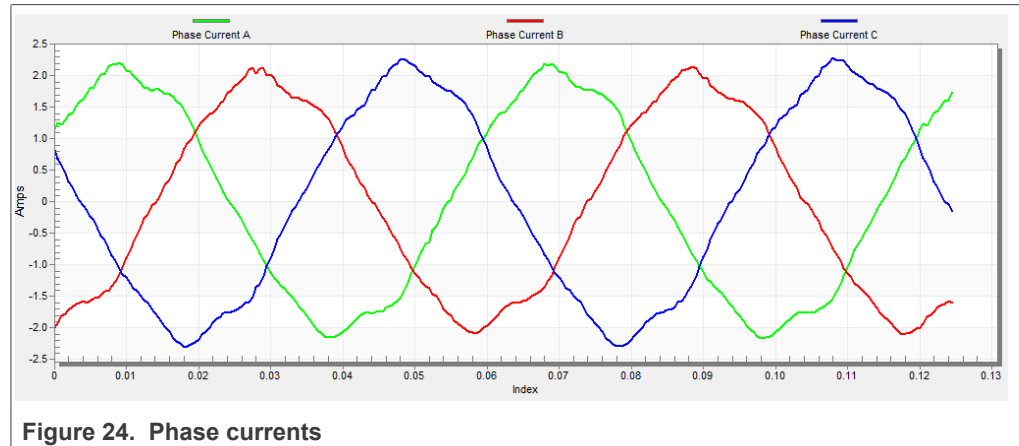

Figure 24. Phase currents

6. Select the “Position” recorder to check the observer functionality. The difference between the “Position Electrical Scalar” and the “Position Estimated” should be minimal (see [Figure 25](#)) for the Back-EMF position and speed observer to work properly. The position difference depends on the motor load. The higher the load, the bigger the difference between the positions due to the load angle.

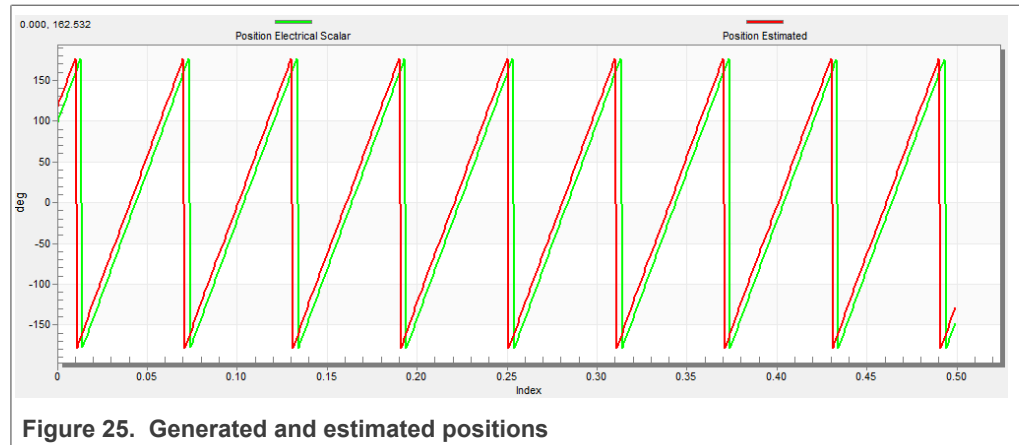

Figure 25. Generated and estimated positions

7. If an opposite speed direction is required, set a negative speed value into the “Freq_req” field.
8. The proper observer functionality and the measurement of analog quantities is expected at this step.
9. Enable the voltage FOC mode by clicking the “DISABLED” button in the “Voltage FOC” section while the main application switch is turned off.
10. Switch the main application switch on and set a non-zero value in the “Uq_req” field. The FOC algorithm uses the estimated position to run the motor.

8.9 Alignment tuning

For the alignment parameters, navigate to the “Parameters” MCAT tab. The alignment procedure sets the rotor to an accurate initial position and enables you to apply full start-up torque to the motor. A correct initial position is needed mainly for high start-up loads (compressors, washers, and so on). The aim of the alignment is to have the rotor in a stable position, without any oscillations before the startup.

1. The alignment voltage is the value applied to the d-axis during the alignment. Increase this value for a higher shaft load.
2. The alignment duration expresses the time when the alignment routine is called. Tune this parameter to eliminate rotor oscillations or movement at the end of the alignment process.

8.10 Current loop tuning

The parameters for the current D, Q, and PI controllers are fully calculated using the motor parameters and no action is required in this mode. If the calculated loop parameters do not correspond to the required response, the bandwidth and attenuation parameters can be tuned.

1. Select “Openloop Control” in the FreeMASTER project tree, set “M1 MCAT Control” to “OPENLOOP_CTRL” and switch “M1 Openloop Use I Control” on.
2. Turn the application on by switching “M1 Application Switch” on and then set “M1 Openloop Required Id” for rotor alignment. (Rotor alignment always uses Id, even when you are tuning the Q axis regulator)
3. Mechanically lock the motor shaft and turn the application off.
4. Set the required loop bandwidth and attenuation in MCAT “Current loop” tab and then click the “Update target” button. The tuning loop bandwidth parameter defines how

fast the loop response is while the tuning loop attenuation parameter defines the actual overshoot magnitude.

5. Select “Current Controller Id” recorder in project tree, turn the application on and set the required step amplitude in “M1 Openloop Required Id”. Observe the step response in the recorder.
6. Tune the loop bandwidth and attenuation until you achieve the required response. The example waveforms show the correct and incorrect settings of the current loop parameters:
 - The loop bandwidth is low (100 Hz) and the settling time of the Id current is long (Figure 26).

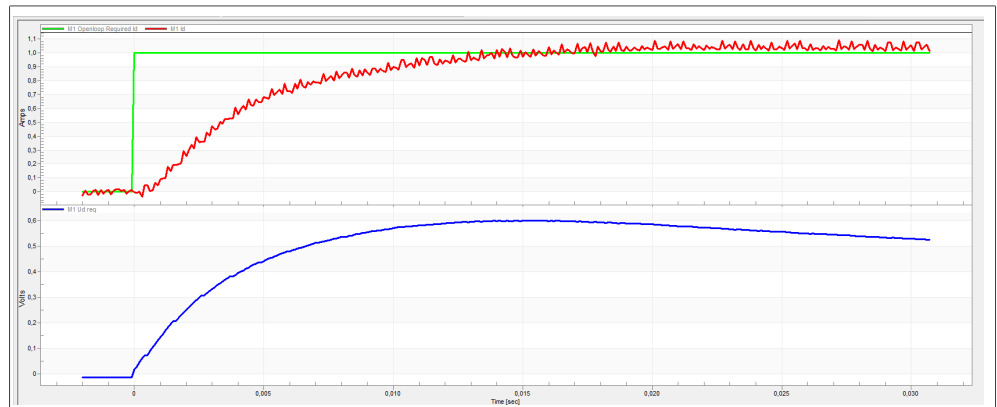

Figure 26. Slow step response of the Id current controller

- The loop bandwidth (300 Hz) is optimal and the response time of the Id current is sufficient (see Figure 27).

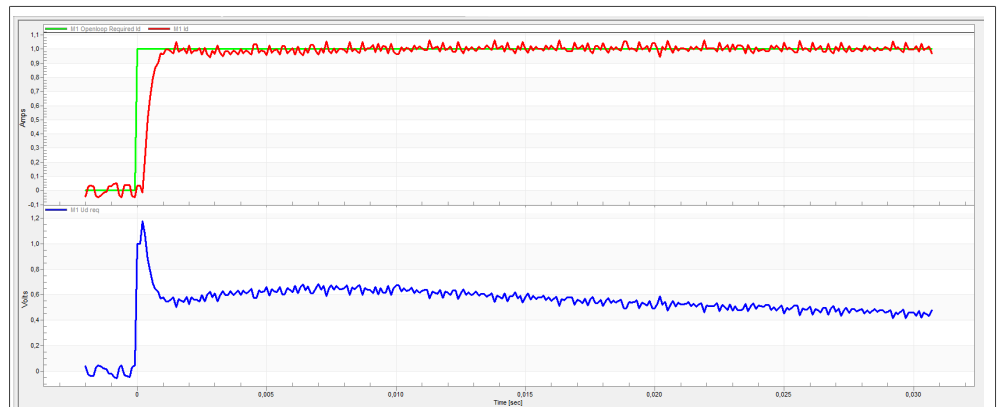

Figure 27. Optimal step response of the Id current controller

- The loop bandwidth is high (700 Hz) and the response time of the Id current is very fast, but with oscillations and overshoot (see Figure 28).

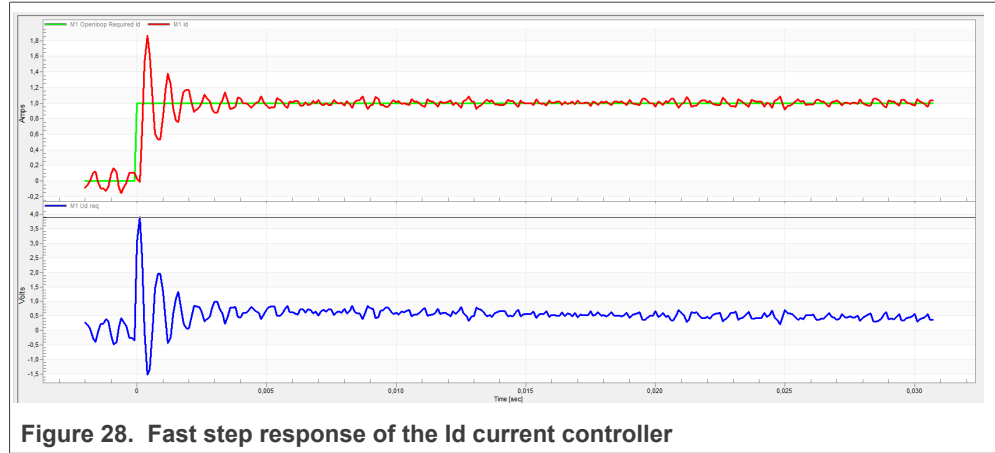

Figure 28. Fast step response of the Id current controller

8.11 Speed ramp tuning

1. The speed command is applied to the speed controller through a speed ramp. The ramp function contains two increments (up and down) which express the motor acceleration and deceleration per second. If the increments are very high, they can cause an overcurrent fault during acceleration and an overvoltage fault during deceleration. In the “Speed” scope, you can see whether the “Speed Actual Filtered” waveform shape equals the “Speed Ramp” profile.
2. The increments are common for the scalar and speed control. The increment fields are in the “Speed loop” tab and accessible in both tuning modes. Clicking the “Update target” button applies the changes to the MCU. An example speed profile is shown in [Figure 29](#). The ramp increment down is set to 500 rpm/sec and the increment up is set to 3000 rpm/sec.
3. The start-up ramp increment is in the “Sensorless” tab and its value is usually higher than that of the speed loop ramp.

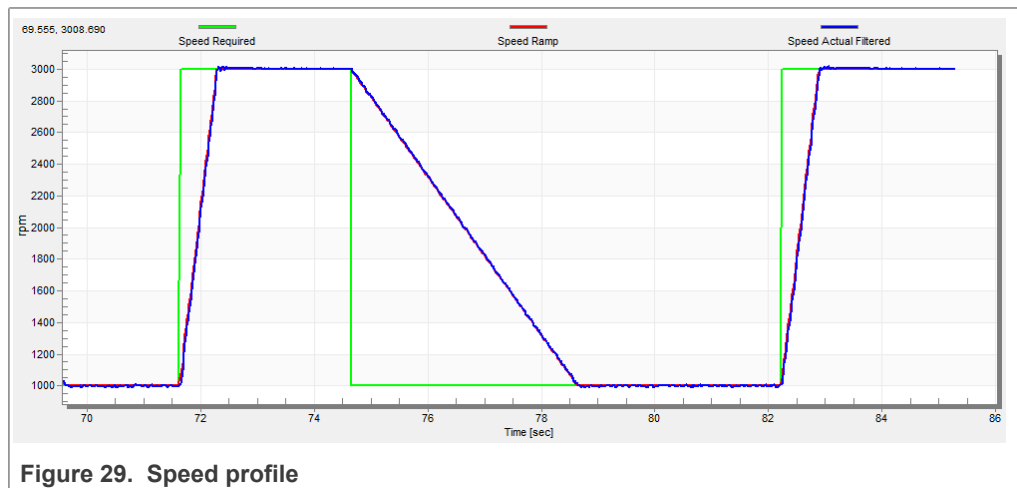

Figure 29. Speed profile

8.12 Open loop startup

1. The start-up process can be tuned by a set of parameters located in the “Sensorless” tab. Two of them (ramp increment and current) are accessible in both tuning modes. The start-up tuning can be processed in all control modes besides the scalar control.

Setting the optimal values results in a proper motor startup. An example start-up state of low-dynamic drives (fans, pumps) is shown in [Figure 30](#).

2. Select the "Startup" recorder from the FreeMASTER project tree.
3. Set the start-up ramp increment typically to a higher value than the speed-loop ramp increment.
4. Set the start-up current according to the required start-up torque. For drives such as fans or pumps, the start-up torque is not very high and can be set to 15 % of the nominal current.
5. Set the required merging speed—when the open-loop and estimated position merging starts, the threshold is mostly set in the range of 5 % ~ 10 % of the nominal speed.
6. Set the merging coefficient—in the position merging process duration, 100 % corresponds to a half of an electrical revolution. The higher the value, the faster the merge. Values close to 1 % are set for the drives where a high start-up torque and smooth transitions between the open loop and the closed loop are required.
7. Click the "Update Target" button to apply the changes to the MCU.
8. Select "SPEED_FOC" in the "M1 MCAT Control" variable.
9. Set the required speed higher than the merging speed.
10. Check the start-up response in the recorder.
11. Tune the start-up parameters until you achieve an optimal response.
12. If the rotor does not start running, increase the start-up current.
13. If the merging process fails (the rotor is stuck or stopped), decrease the start-up ramp increment, increase the merging speed, and set the merging coefficient to 5 %.

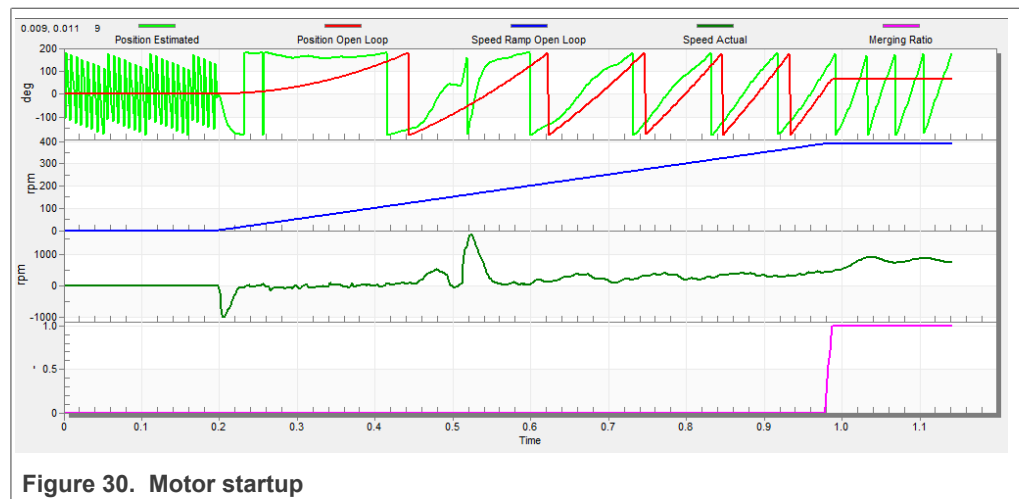

8.13 BEMF observer tuning

1. The bandwidth and attenuation parameters of the BEMF observer and the tracking observer can be tuned. Navigate to the "Sensorless" MCAT tab.
2. Set the required bandwidth and attenuation of the BEMF observer—the bandwidth is typically set to a value close to the current loop bandwidth.
3. Set the required bandwidth and attenuation of the tracking observer—the bandwidth is typically set in the range of 10 – 20 Hz for most low-dynamic drives (fans, pumps).
4. Click the "Update target" button to apply the changes to the MCU.
5. Select the "Observer" recorder from the FreeMASTER project tree and check the observer response in the "Observer" recorder.

8.14 Speed PI controller tuning

The motor speed control loop is a first-order function with a mechanical time constant that depends on the motor inertia and friction. If the mechanical constant is available, the PI controller constants can be tuned using the loop bandwidth and attenuation. Otherwise, the manual tuning of the P and I portions of the speed controllers is available to obtain the required speed response (see the example response in [Figure 31](#)). There are dozens of approaches to tune the PI controller constants. The following steps provide an approach to set and tune the speed PI controller for a PM synchronous motor:

1. Select the “Speed Controller” option from the FreeMASTER project tree.
2. Select the “Speed loop” tab.
3. Check the “Manual Constant Tuning” option—that is, the “Bandwidth” and “Attenuation” fields are disabled and the “SL_Kp” and “SL_Ki” fields are enabled.
4. Tune the proportional gain:
 - Set the “SL_Ki” integral gain to 0.
 - Set the speed ramp to 1000 rpm/sec (or higher).
 - Run the motor at a convenient speed (about 30 % of the nominal speed).
 - Set a step in the required speed to 40 % of N_{nom} .
 - Adjust the proportional gain “SL_Kp” until the system responds to the required value properly and without any oscillations or excessive overshoot:
 - If the “SL_Kp” field is set low, the system response is slow.
 - If the “SL_Kp” field is set high, the system response is tighter.
 - When the “SL_Ki” field is 0, the system most probably does not achieve the required speed.
 - Click the “Update Target” button to apply the changes to the MCU.
5. Tune the integral gain:
 - Increase the “SL_Ki” field slowly to minimize the difference between the required and actual speeds to 0.
 - Adjust the “SL_Ki” field such that you do not see any oscillation or large overshoot of the actual speed value while the required speed step is applied.
 - Click the “Update target” button to apply the changes to the MCU.
6. Tune the loop bandwidth and attenuation until the required response is received. The example waveforms with the correct and incorrect settings of the speed loop parameters are shown in the following figures:
 - The “SL_Ki” value is low and the “Speed Actual Filtered” does not achieve the “Speed Ramp” (see [Figure 31](#)).

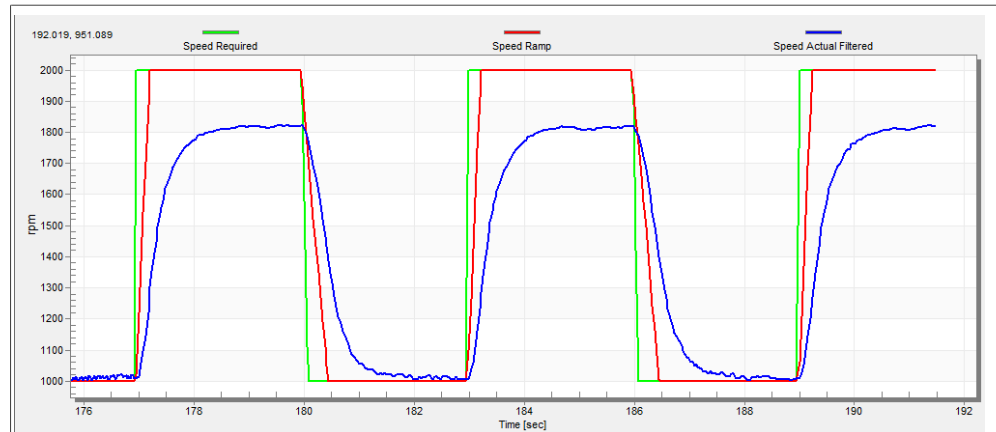

Figure 31. Speed controller response—SL_Ki value is low, Speed Ramp is not achieved

- The “SL_Kp” value is low, the “Speed Actual Filtered” greatly overshoots, and the long settling time is unwanted (see [Figure 32](#)).

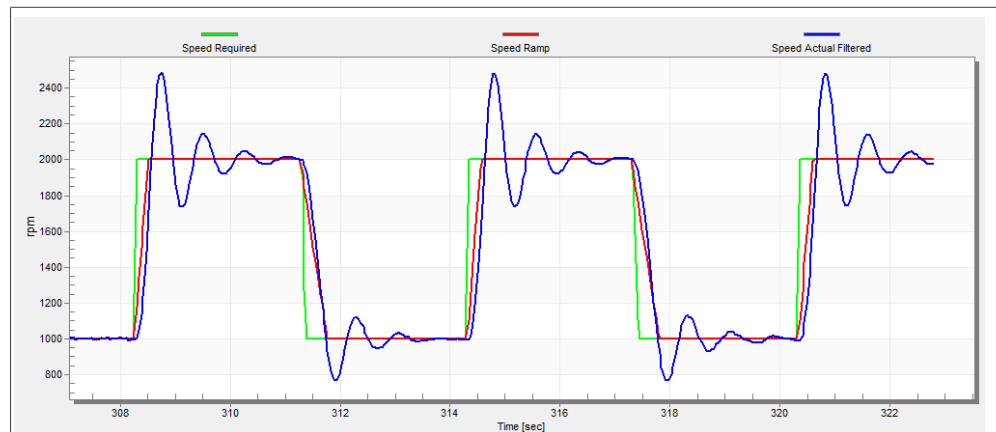
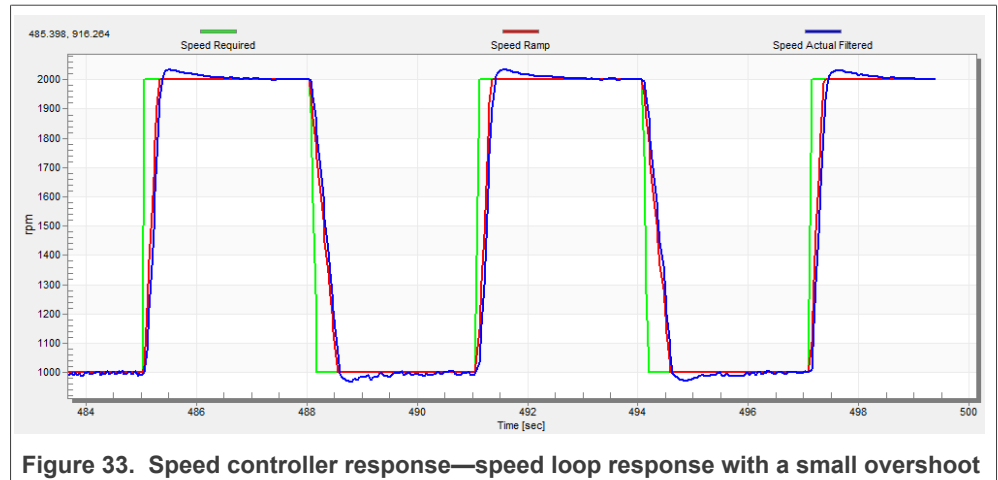

Figure 32. Speed controller response—SL_Kp value is low, Speed Actual Filtered greatly overshoots

- The speed loop response has a small overshoot and the “Speed Actual Filtered” settling time is sufficient. Such response can be considered optimal (see [Figure 33](#)).



9 Conclusion

This application note describes the implementation of the sensor and sensorless Field-Oriented Control of a 3-phase PMSM on the NXP MC56F8xxxx series device. The hardware-dependent part of the control software is described in [Section 2](#). The motor-control application timing and peripheral initialization were described in the chapter about MC56F8xxxx series features. The motor user interface and remote control using FreeMASTER are as follows. The motor parameters identification theory and the identification algorithms are described in [Section 8](#).

10 Acronyms and abbreviations

Table 9. Acronyms and abbreviations

Acronym	Meaning
ADC	Analog-to-Digital Converter
ACIM	Asynchronous Induction Motor
ADC_ETC	ADC External Trigger Control
AN	Application Note
BLDC	Brushless DC motor
CCM	Clock Controller Module
CPU	Central Processing Unit
DC	Direct Current
DRM	Design Reference Manual
ENC	Encoder
FOC	Field-Oriented Control
GPIO	General-Purpose Input/Output
LPIT	Low-power Periodic Interrupt Timer
LPUART	Low-power Universal Asynchronous Receiver/Transmitter
MCAT	Motor Control Application Tuning tool

Table 9. Acronyms and abbreviations...continued

Acronym	Meaning
MCDRV	Motor Control Peripheral Drivers
MCU	Microcontroller
PDB	Programmable Delay Block
PI	Proportional Integral controller
PLL	Phase-Locked Loop
PMSM	Permanent Magnet Synchronous Machine
PWM	Pulse-Width Modulation
QD	Quadrature Decoder
TMR	Quad Timer
USB	Universal Serial Bus
XBAR	Inter-Peripheral Crossbar Switch
IOPAMP	Internal operational amplifier

11 References

These references are available on www.nxp.com:

1. *Sensorless PMSM Field-Oriented Control* (document [DRM148](#)).
2. *Motor Control Application Tuning (MCAT) Tool for 3-Phase PMSM* (document [AN4642](#)).

12 Useful links

1. PMSM Control Reference Design www.nxp.com/motorcontrol_pmsm
2. BLDC Control Reference Design www.nxp.com/motorcontrol_bldc
3. ACIM Control Reference Design www.nxp.com/motorcontrol_acim
4. [FRDM-MC-PMSM Freedom Development Platform](#)
5. [MC56F80xxx Digital Signal Controller \(DSC\) family](#)
6. [Get Started with the MC56F81000-EVK](#)
7. [Get Started with the MC56F83000-EVK](#)
8. [CodeWarrior IDE](#)
9. MCUXpresso SDK Builder (SDK examples in several IDEs) <https://mcuxpresso.nxp.com/en/welcome>

13 Revision history

[Table 10](#) summarizes the changes done to the document since the initial release.

Revision history

Revision number	Date	Substantive changes
0	12/2022	Initial release

How To Reach Us**Home Page:**nxp.com**Web Support:**nxp.com/support

Information in this document is provided solely to enable system and software implementers to use NXP products. There are no express or implied copyright licenses granted hereunder to design or fabricate any integrated circuits based on the information in this document. NXP reserves the right to make changes without further notice to any products herein.

NXP makes no warranty, representation, or guarantee regarding the suitability of its products for any particular purpose, nor does NXP assume any liability arising out of the application or use of any product or circuit, and specifically disclaims any and all liability, including without limitation consequential or incidental damages. "Typical" parameters that may be provided in NXP data sheets and/or specifications can and do vary in different applications, and actual performance may vary over time. All operating parameters, including "typicals," must be validated for each customer application by customer's technical experts. NXP does not convey any license under its patent rights nor the rights of others. NXP sells products pursuant to standard terms and conditions of sale, which can be found at the following address: nxp.com/SalesTermsandConditions.

While NXP has implemented advanced security features, all products may be subject to unidentified vulnerabilities. Customers are responsible for the design and operation of their applications and products to reduce the effect of these vulnerabilities on customer's applications and products, and NXP accepts no liability for any vulnerability that is discovered. Customers should implement appropriate design and operating safeguards to minimize the risks associated with their applications and products.

NXP, the NXP logo, NXP SECURE CONNECTIONS FOR A SMARTER WORLD, COOLFLUX, EMBRACE, GREENCHIP, HITAG, I2C BUS, ICODE, JCOP, LIFE VIBES, MIFARE, MIFARE CLASSIC, MIFARE DESFire, MIFARE PLUS, MIFARE FLEX, MANTIS, MIFARE ULTRALIGHT, MIFARE4MOBILE, MIGLO, NTAG, ROADLINK, SMARTLX, SMARTMX, STARPLUG, TOPFET, TRENCHMOS, UCODE, Freescale, the Freescale logo, AltiVec, C-5, CodeTEST, CodeWarrior, ColdFire, Cold Fire+, C-Ware, the Energy Efficient Solutions logo, Kinetis, Layerscape, MagniV, mobileGT, PEG, PowerQUICC, Processor Expert, QorIQ, QorIQ Qonverge, Ready Play, SafeAssure, the SafeAssure logo, StarCore, Symphony, VortiQa, Vybrid, Airfast, BeeKit, BeeStack, CoreNet, Flexis, MXC, Platform in a Package, QUICC Engine, SMARTMOS, Tower, TurboLink, UMEMS, EdgeScale, EdgeLock, eIQ, and Immersive3D are trademarks of NXP B.V. All other product or service names are the property of their respective owners. AMBA, Arm, Arm7, Arm7TDMI, Arm9, Arm11, Artisan, big.LITTLE, Cordio, CoreLink, CoreSight, Cortex, Design Start, DynamIQ, Jazelle, Keil, Mali, Mbed, Mbed Enabled, NEON, POP, RealView, SecurCore, Socrates, Thumb, TrustZone, ULINK, ULINK2, ULINK-ME, ULINK-PLUS, ULINKpro, μ Vision, Versatile are trademarks or registered trademarks of Arm Limited (or its subsidiaries) in the US and/or elsewhere. The related technology may be protected by any or all of patents, copyrights, designs and trade secrets. All rights reserved. Oracle and Java are registered trademarks of Oracle and/or its affiliates. The Power Architecture and Power.org word marks and the Power and Power.org logos and related marks are trademarks and service marks licensed by Power.org.

Tables

Tab. 1.	Linux 45ZWN24-40 motor parameters	3	Tab. 5.	Measurement faults and warnings	24
Tab. 2.	MC56F80000-EVK jumper settings	3	Tab. 6.	MCAT motor parameters	24
Tab. 3.	MC56F80748 CPU load and memory usage (SDM model)	7	Tab. 7.	Fault limits	25
Tab. 4.	MC56F80748 CPU load and memory usage (LDM model)	7	Tab. 8.	Application scales	25
			Tab. 9.	Acronyms and abbreviations	33

Figures

Fig. 1.	Motor-control development platform block diagram	2	Fig. 18.	Running a new PMSM	19
Fig. 2.	FRDM-MC-LVPMSM	2	Fig. 19.	Example power stage characteristic	20
Fig. 3.	Linux 45ZWN24-40 permanent magnet synchronous motor	3	Fig. 20.	Tuning Ls measuring signal	21
Fig. 4.	MC56F80000-EVK board	4	Fig. 21.	PMSM identification tab	23
Fig. 5.	MC56F80xxx block diagram	5	Fig. 22.	Measurement process diagram	23
Fig. 6.	Hardware timing and synchronization on MC56F80748	6	Fig. 23.	MCAT scalar control	26
Fig. 7.	Directory tree	8	Fig. 24.	Phase currents	26
Fig. 8.	Green “GO” button placed in top left-hand corner	12	Fig. 25.	Generated and estimated positions	27
Fig. 9.	FreeMASTER—communication is established successfully	12	Fig. 26.	Slow step response of the Id current controller	28
Fig. 10.	FreeMASTER communication setup window	13	Fig. 27.	Optimal step response of the Id current controller	28
Fig. 11.	MCAT layout	14	Fig. 28.	Fast step response of the Id current controller	29
Fig. 12.	MCAT for PMSM control page	15	Fig. 29.	Speed profile	29
Fig. 13.	Scalar control mode	16	Fig. 30.	Motor startup	30
Fig. 14.	Voltage FOC control mode	16	Fig. 31.	Speed controller response—SL_Ki value is low, Speed Ramp is not achieved	32
Fig. 15.	Current (torque) control mode	17	Fig. 32.	Speed controller response—SL_Kp value is low, Speed Actual Filtered greatly overshoots	32
Fig. 16.	Speed FOC control mode	17	Fig. 33.	Speed controller response—speed loop response with a small overshoot	33
Fig. 17.	FreeMASTER control page	18			

Contents

1	Introduction	1
2	Hardware setup	1
2.1	FRDM-MC-LVPMSM	1
2.2	Linux 45ZWN24-40 motor	2
2.3	MC56F80000-EVK	3
2.3.1	Hardware assembling	4
3	MC56F8xxxx series features and peripheral settings	4
3.1	MC56F80xxx	4
3.1.1	MC56F80748 - Hardware timing and synchronization	5
3.1.2	MC56F80xxx - Peripheral settings	6
3.2	CPU load and memory usage	6
4	Project file and IDE workspace structure	8
4.1	PMSM project structure	8
5	Motor-control peripheral initialization	9
6	User interface	11
7	Remote control using FreeMASTER	11
7.1	Establishing FreeMASTER communication	12
7.2	MCAT FreeMASTER interface (Motor Control Application Tuning)	13
7.2.1	Control structure—"Control Struc" tab	15
7.2.2	Application demo control—"App control" tab	17
8	Identifying parameters of user motor using MCAT	18
8.1	Power stage characterization	19
8.2	Stator resistance measurement	20
8.3	Stator inductance	20
8.4	BEMF constant measurement	21
8.5	Number of pole-pair assistant	22
8.6	PMSM electrical and parameters measurement process	22
8.7	Initial configuration setting and update	24
8.8	Control structure modes	25
8.9	Alignment tuning	27
8.10	Current loop tuning	27
8.11	Speed ramp tuning	29
8.12	Open loop startup	29
8.13	BEMF observer tuning	30
8.14	Speed PI controller tuning	31
9	Conclusion	33
10	Acronyms and abbreviations	33
11	References	34
12	Useful links	34
13	Revision history	34
14	35