

AN12334

Starting a product development with CLRC663 *plus* family

Rev. 1.0 — 9 July 2019

523210

Application note
COMPANY PUBLIC

Document information

Information	Content
Keywords	CLRC663, CLRC663 plus, CLEV663B, CLRC663 plus evaluation board, CLRC663 plus customer board, CLRC663 plus GUI, GUI, CLRC663 plus Support Tool, NFC Cockpit
Abstract	This document describes the steps toward development of an NFC reader board and how to use available tools to achieve it. It describes briefly how to use NFC Cockpit to properly configure CLRC663 plus registers and EEPROM, aiming an optimum design, in combination with basic reader functionality, given well-defined boundary conditions (antenna dimensions, desired use cases and aimed qualifications).



Revision history

Revision history

Rev	Date	Description
1.0	20190709	First release

1 Introduction

1.1 Introduction to CLRC663, an NFC Front-end reader

CLRC663 *plus* is a High-Performance Multi-Protocol ISO/IEC14443 Front end. The high RF output power, innovative features and development tools help to finalize a design successfully within shortest time.

CLRC663 *plus* is a partial NFC-compliant frontend IC which can be used for Reader mode, and in Peer to Peer Mode (passive initiator P2P); the high transmitter current available drain current makes CLRC663 *plus* a good choice for all applications which require high RF output power, Home banking, physical and logic access control. The CLRC663 *plus* allows the design of EMVCo 3.0 compliant payment terminals. However, for fastest time to market and highest flexibility by software, the PN5180 is recommended. P2P interoperability with typical mobile phones had been tested, which reduces the risk of problems after a product launch.

This document gives an overview of all available tools, documentation and material facilitating the Contactless Implementation process.

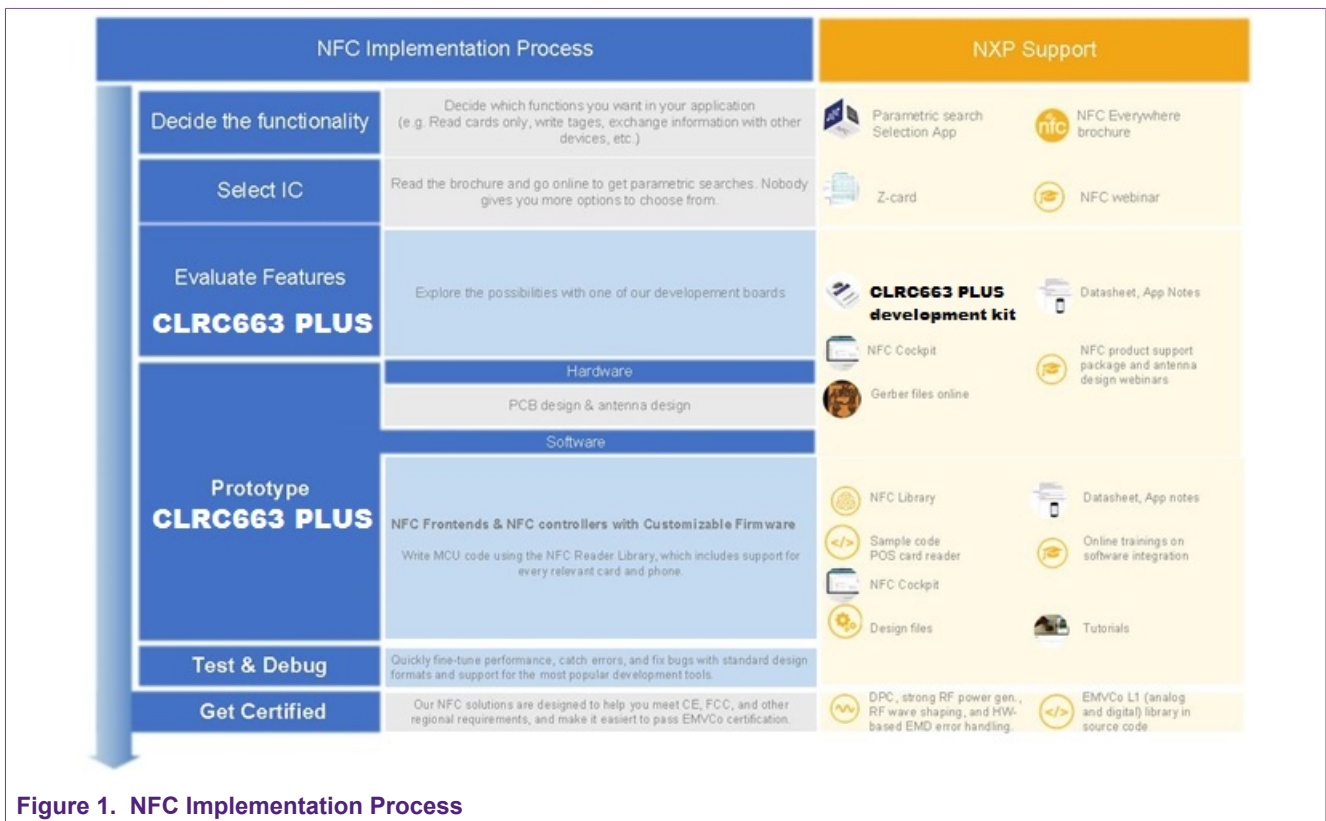

Figure 1. NFC Implementation Process

1.1.1 Deciding on Reader functionality

The NFC implementation process starts typically with the decision which functionality shall be implemented and the selection of the product fitting to the targeted application requirements. The following support material may help in the decision process:

- Our website has [online selection tools](#), using our parametric search the right product can be selected (see [1]).
- [The line card](#) with NFC Reader Portfolio, called Z-card, show all NFC products in comparison and help to find the IC fulfilling all requirements.
- Our [NFC Everywhere brochure](#) guides you through all use case and gives recommendation on the product to be selected. A variation of the same brochure is also present [here](#).
- Webinars on all use cases as well as on our products are available in our [on-demand library](#).

In the following chapters the product support material for CLRC663 *plus* are described, facilitating the next steps in the implementation process:

- [Evaluating Features](#)
- [Prototyping Hardware](#)
- [Prototyping Software](#)
- [Testing & Debugging](#)
- [Getting Certified](#)

2 Evaluating features

If the product characteristics of the CLRC663 *plus* match the requirements of the application, an evaluation of the product can be planned and facilitated by the following enablement tools.

2.1 OM26630 FDK Development kit

There are currently three different CLRC663-equipped development kits: - two based on last version CLRC663, named CLRC663 *plus*, and one based on former CLRC663 version. They can be ordered using the following order numbers from NXP through many distribution partners, or through “buy-direct” option in our NXP website:

Order Number: 935339151699

Name: OM26630FDK



Figure 2. Blister containing OM26630FDK development kit

It contains a CLEV6630BM board with LPC1769 microcontroller connected to the CLRC663 *plus* and a ready to use 65x65mm antenna. Furthermore, blister contains an additional 30 mm x 50 mm antenna with matching components, optimized for NFC applications, three small antenna matching PCBs (approximately 20 mm x 40 mm sized, intended for implementation of a custom antenna matching circuit), one NFC sample card based on NTAG216F (NFC Forum Type 2 Tag - allowing a first check of the boards functionality) and 10 CLRC663 *plus* samples in HVQFN package, to support quick prototyping.

The kit can be purchased from your [favorite distributor](#).

2.2 CLEV6630AM Development kit

Order Number: 935339148699

Name: CLEV6630AM

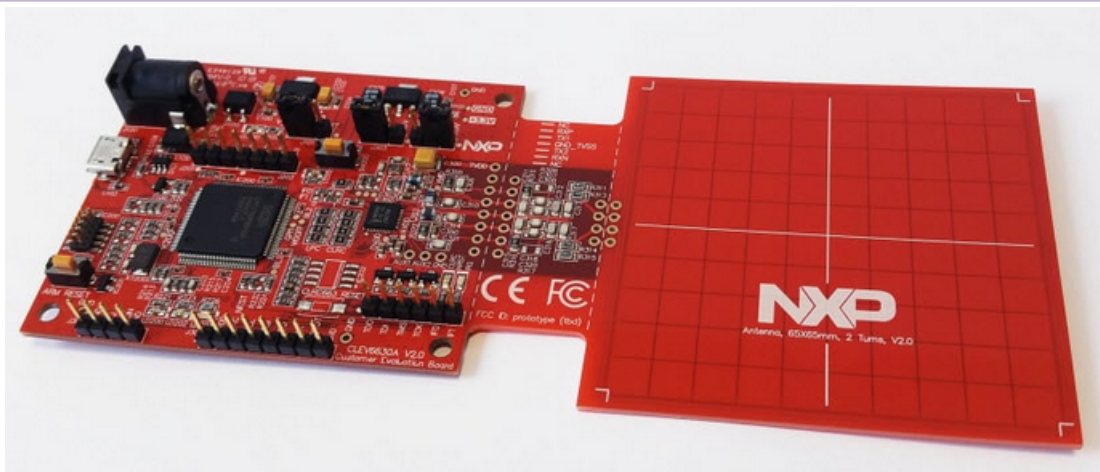

Figure 3. CLEV6630AM development kit

The objective of this kit is to allow development of MFRC630 and SLRC610 Frontends. It uses a default antenna matching with lower transmitter current compared to the CLEV663B

2.3 CLRC663 *plus* and QN902x NFC-Bluetooth® Low Energy solution for consumer applications

Order Number: 935340469598

Name: BLE-NFC-V2



Figure 4. BLE-NFC-V2 demo kit

The Bluetooth Low Energy-NFC-v2.0 is an NFC add-on board for QN9020DK, the extensible platform for application development of QN9020. The NFC add-on board is based on CLRC663 *plus*, the high-performance multi-protocol NFC Frontend.

Combining these two boards brings a solution for fast prototype development enabled by the production-ready NFC and Bluetooth Low Energy firmware for QN9020 and an iOS® application framework for control and communication. Big advantage of this demo board is the Arduino R-3 pinning which allows connecting to other NXP MCU-based demoboard, like LPC55S69-EVK, i.MX RT1050 EVK, FRDM-K64F, etc.

2.4 OM29263ADK: NFC Antenna Development Kit

Order Number: 935361598598

Name: OM29263ADK

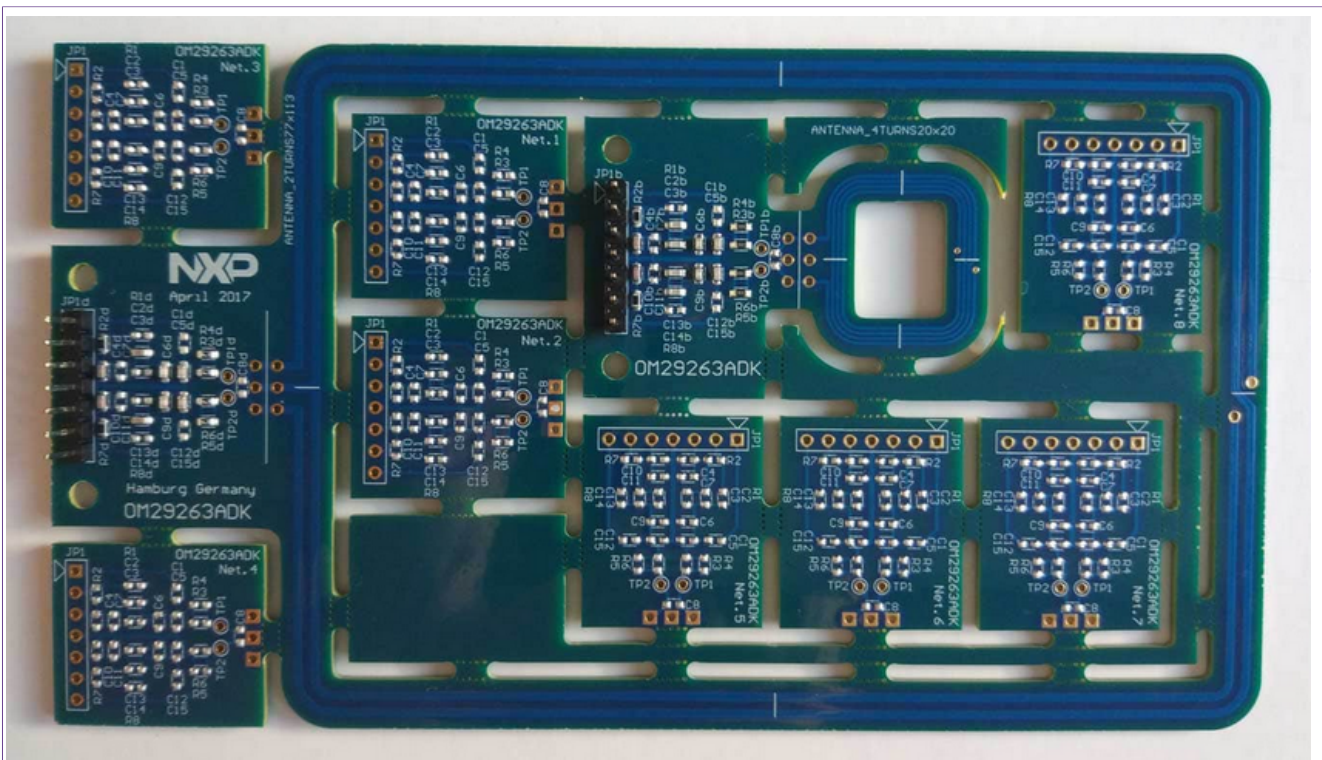

Figure 5. NFC Antenna Development kit

The NFC antenna development kit is a set of 2 ready-to-use pre-matched antennas for use with the CLRC663 development boards. It consists of the popular 4 turns 20x20mm² and the 2 turns 77x113mm² antennas. It complements the standard 2 turns 65x65 mm² antenna and comes in addition of the 3 turns 30x50mm² antenna present in the CLRC663 *plus* development kit (OM26630FDK).

The NFC antenna development kit is also compatible with the CLRC663 development board (CLEV6630A) and can be optimized for the PN5180 (PNEV5180B/OM25180FDK) and PN7462 family (PNEV7462C/OM27462CDKP) development boards/kits using the 8 included antenna matching PCBs following the instructions in the quick start guide.

This NFC antenna development kit is the perfect tool to best evaluate the performance of different antenna shapes and the quickest way to RF antenna prototyping.

There is a public webinar showing all possibilities offered by this development kit: <https://www.nxp.com/video:/ANTENNA-DESIGN-OM29263ADK>

2.5 NFC Cockpit use with OM26630FDK and CLEV6630AM

The same CLRC663-equipped development kits can be used in two ways:

1. Demoboard connected to PC, making use NFC Cockpit tool
2. Stand alone reader (embedded application) making use of firmware to be loaded into MCU flash.

The easiest option is to use the kit together with the PC-based graphical configuration tool NFC Cockpit, which can be downloaded [here](#).

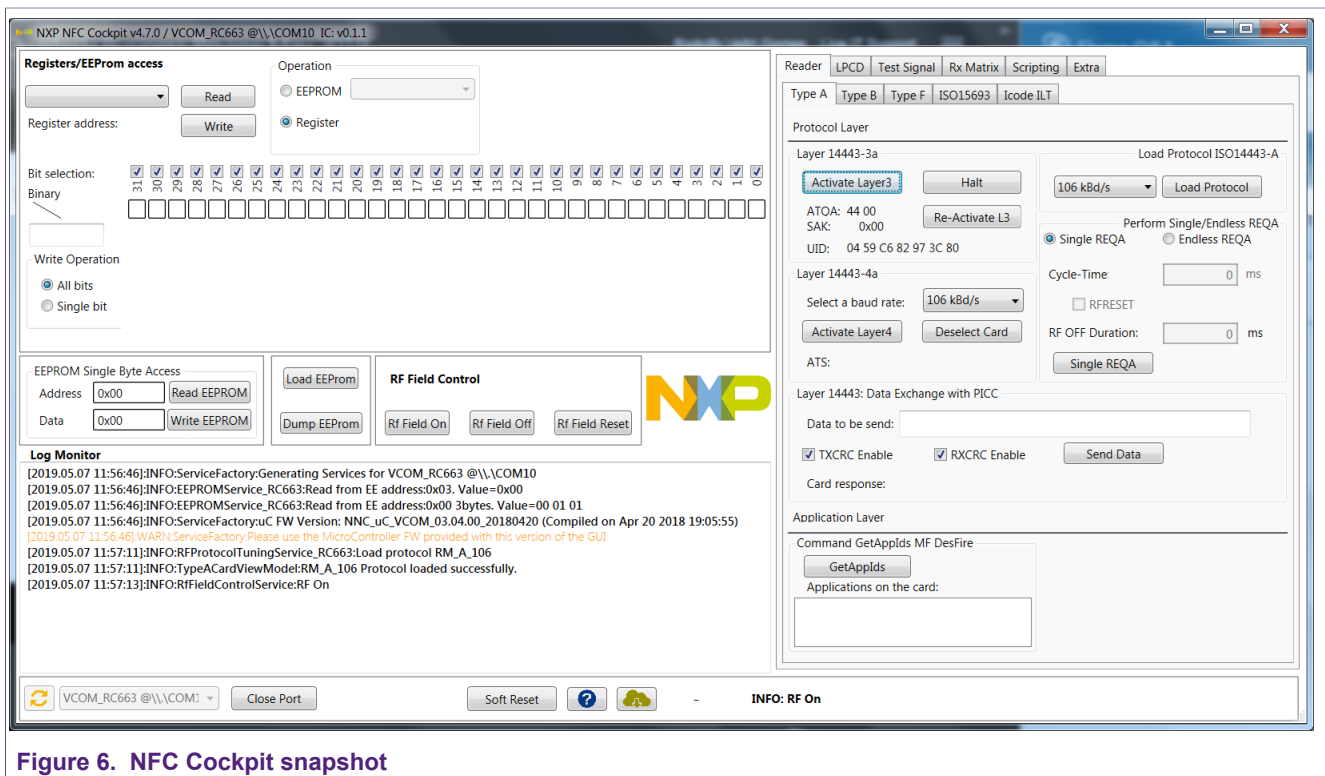

Figure 6. NFC Cockpit snapshot

The NFC Cockpit can be installed on any windows PC and the CLEV can be connected to the PC through USB interface. The tool allows an immediate test of the RF-Performance of the CLEV demoboards. Documents containing info about installation and use of NFC Cockpit can be found in [2]. For the use of CLEV663B as an embedded reader, please read chapter related to [NFC Reader Library](#)

2.5.1 Additional resources: recorded webinar on “Introduction to NFC Cockpit tool”

<http://www.nxp.com/video:/NFC-APPLICATION-COCKPIT>

2.6 Application notes and data sheet

The public NXP website gives an [overview on CLRC663](#) family and allows a quick access to all public support material.

The latest data sheets of CLRC663 and derivatives ([8], [9], [10] and [11]) are available for download and give all information about the functionality and characteristics of the product family. Additional documents which require an NDA are available on the NXP

DocStore (<https://www.docstore.nxp.com>). Such documents include, for example, a description of the CLRC663 in BGA package, EMVCo certification test reports, and all necessary info for CLRC663 firmware update.

2.7 Additional resources: recorded webinars on CLRC663 family

Browse here:

<https://www.nxp.com/video/clrc663-plus-push-your-nfc-design-further:CLRC663-CHARACTERISTICS-VID>

<https://www.nxp.com/video/clrc663-iplus-i-short-reel:CLRC663PLUS-SHORT-REEL>

If link above do not work in your browser, search for this keyword "CLRC663PLUS" in the general video directory link above: <https://www.nxp.com/video/vault/?searchLabel=renderSearchPage&q=NFC>

3 Hardware development of a prototype reader

3.1 RF reader design and matching between RF output and customer antenna

After the choice of NFC chip reader, next major choice to be done is on the final antenna topology; besides geometric boundary conditions, the use case and aimed certifications will impact on antenna layout and requirements.

Extensive explanation around Reader RF performance versus customer application is given in [3]. It is important that customer does not expect strong performance from a very tiny/small antenna. If available space is really reduced, then NXP advises customer to get in touch with NXP partner specialized in antenna manufacturing to avoid frustration. Antenna synthesis is a critical development and some end product configuration, like presence of TFT displays, ground chassis all around reader pcb might influence antenna performance. All such RF boundary conditions should be taken into account during feasibility study mainly if NFC reader is a candidate for EMVCo qualification [3], [4], [5] and [6].

3.1.1 Antenna design guide

For the antenna synthesis, freeware applications can be widely found on web or it is possible to use formulae available for circular antenna and rectangular antenna.

3.1.1.1 Rectangular antenna calculations

For the application of a commercial product the 65x65mm antenna (present in CLRC663 development kit blister) is not recommended. The antenna PCB shows copper field strength damping areas in the middle of the antenna to simulate the performance which can be expected in a real life application if the antenna is used in free air. These copper areas shall be in any case removed on antennas for a commercial product.

The antenna of a commercial product will typically be surrounded by either metal, or an application PCB with copper ground planes can be found in the proximity below the antenna. The resulting performance of such an antenna without copper field strength damping areas, but with damping metal in proximity of the antenna can be expected to be similar. In any case a dedicated antenna tuning and matching will be required for this new antenna in a dedicated mounting environment. The application note describing the details of the antenna matching is "[CLRC663 Antenna design guide](#)" [3].

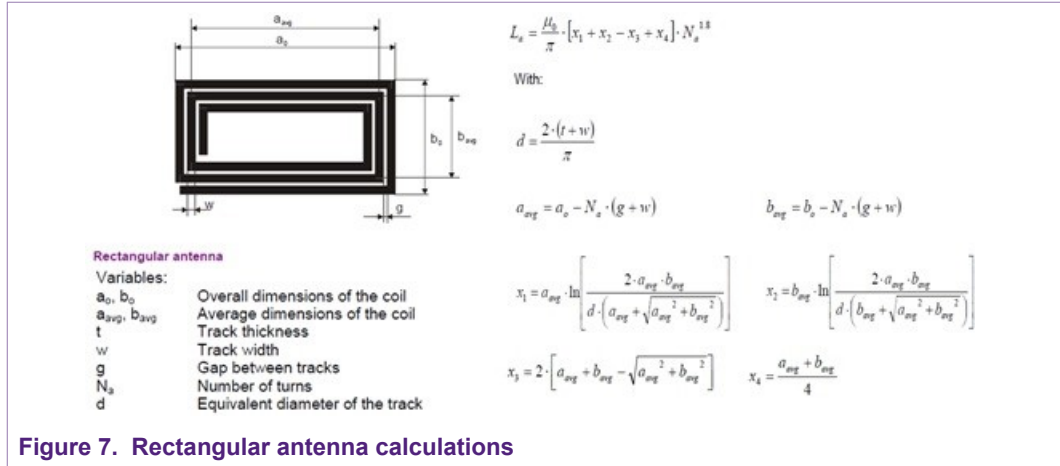

3.1.1.2 Circular antenna calculations

As alternative to rectangular antenna, it is possible to synthesize circular antennas, according to following formulae:

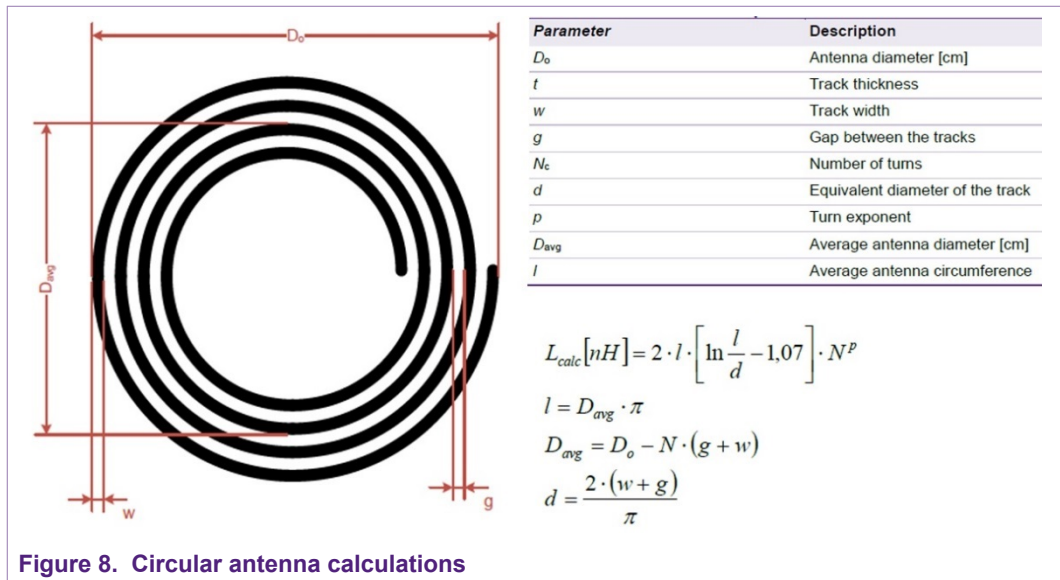

3.1.1.3 Online antenna tool

As alternative way to synthesize rectangular antennae (or transponder antennae) as well as estimating matching network passive values (inductors, capacitors and damping resistors), NXP made an online antenna tool available in the section named [NFC Antenna Design Hub](#).

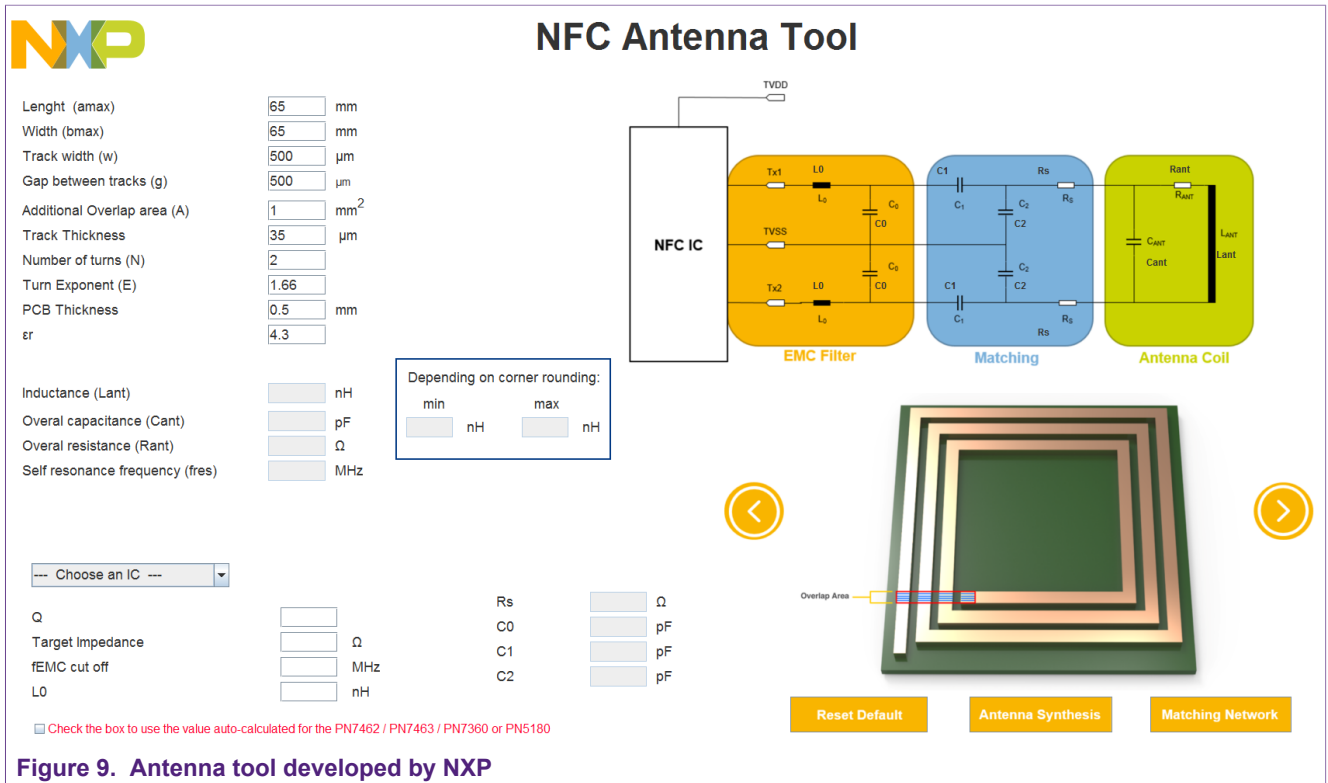
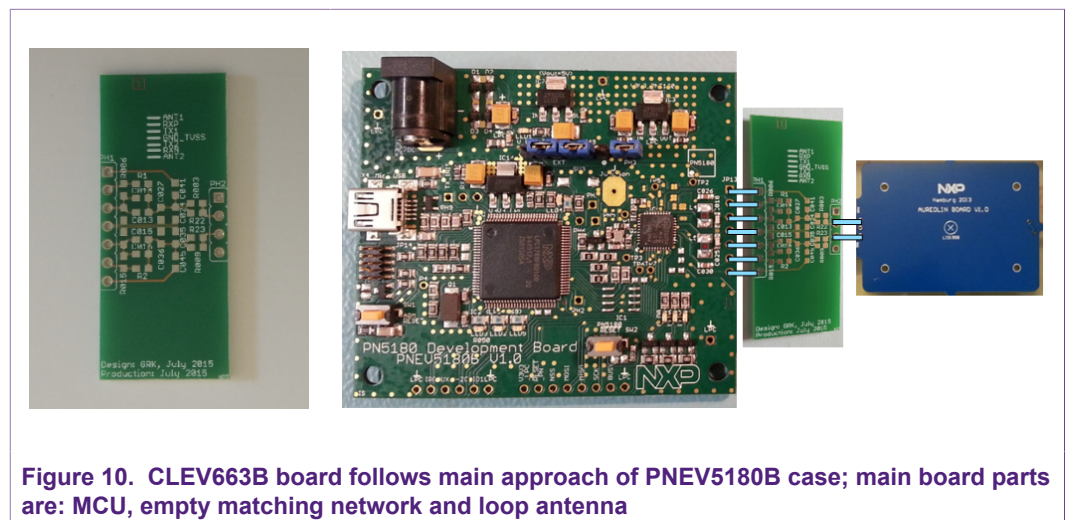

Figure 9. Antenna tool developed by NXP

There is also a recorded webinar to explain how to use such tool, searching for [NFC antenna design hub](#) in nxp.com.

3.1.2 Development kit preparation for matching

Like in the case of PN5180-related boards, also OM26630 FDK contains 3 small PCBs which can be used to implement own matching values for a user-specific antenna. The EMC filter components L_{EMC} , C_{EMC} mounted on the main part of the PCB which contains CLRC663 and LPC1769 can typically be left unchanged.



3.2 Antenna multiplexing concept

NXP has prepared a specific application note dedicated to antenna multiplexing, that is, demonstrating the convenience of using one active reader device and more than one antenna, which is selectable by RF switching system: each antenna is active in a limited time slot enabling use cases in which more than one tag can be detected within a scan period in different areas of the same equipment. This enables multiple tag detections in complex geometries, like in video games, white good devices, kitchen robots and other electronic devices for which detecting the presence of tools is important for safety reasons or to execute specific tasks, like recipes or actions within a video game. NXP proposes an RF switching principle based on MOSFETs connected to different antennas: - while one MOSFET is in high impedance mode, its corresponding antenna is active; at the same time, all other MOSFETs represent short circuit for magnetic current on other remaining antennas; this is well explained in [\[13\]](#).

Particularly interesting is the NXP simplified 4-multiplexer pcb board controlled by Windows-based GUI; the MCU firmware as well as java-based GUI have been developed by NXP for testing such multiplexing concept using CLRC663 demoboards (both A and B versions): customer just needs to cut available demoboards at the matching network limit and solder male-female connections to multiplexer board (see picture below). From multiplexer PCB board, it is possible to connect up to 4 different antennas. Please get in touch with your NXP local representative to get more info about this multiplexer HW and SW.

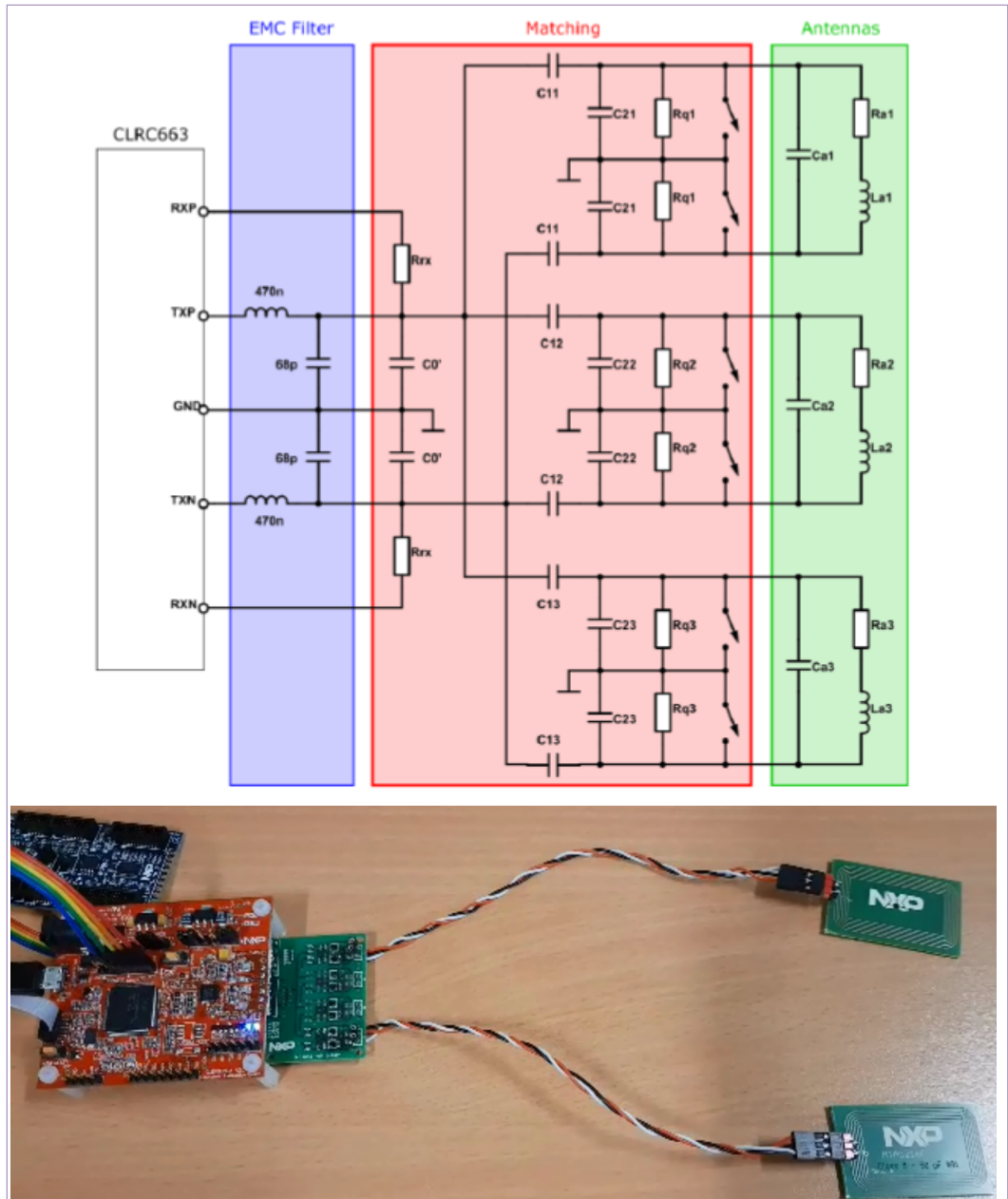

Figure 11. CLEV663A board used in an antenna multiplexer configuration based on MOSFETS: original demoboard is cut at the limit of matching network since antenna matching is developed on multiplexer PCB

3.3 Antenna design additional information

NXP has prepared specific antenna design recorded webinars (and respective presentation slides) which can be found in following links:

Table 1. NXP webinars on antenna design

Webinar Title	Agenda	Presentation & Recorded Webinar
---------------	--------	---------------------------------

1	Which Antenna for what purpose?	<ul style="list-style-type: none"> • What is the best antenna size & form? • Major design parameters • Layout & design tips 	Recorded webinar Materials
2	Antenna „Matching“	<ul style="list-style-type: none"> • What does „matching“ mean? • What are the required simulation tools? • What are the required measurement tools? 	Recorded webinar Materials
3	Metal environment	<ul style="list-style-type: none"> • How does metal environment influence the antenna? • How to use ferrite? • Generic guidelines regarding metal 	Recorded webinar Materials
4	Optimization & Debugging	<ul style="list-style-type: none"> • How can I optimize the performance? • Relevant test signals & registers • Major test & debug setup 	Recorded webinar Materials

3.4 Analog Dynamic Power Control

DPC is a very important added value of CLRC663 as high-power reader, that is, it is the capability to tune output power level as function of transponder vicinity: the closer a card is to reader antenna, the less power reader should issue to execute a transaction. This can be achieved after proper design, fine-tuning and enabling of DPC.

The unique feature Dynamic Power Control (DPC) allows controlling the output power dependent on the loading condition of the antenna. This feature allows using the full transmitter output power for conditions in which a card is far away from the antenna. The DPC senses if a card or mobile phone is approaching the antenna and reduces the transmitter output power accordingly to avoid a RF-field which is too strong in close antenna proximity to meet the standard requirements of e.g. ISO/IEC14443. All this behavior can be fully configured by the developer, but runs fully automatic and in real time without any host processor interaction.

It is important to know that the special features of the IC like Dynamic Power Control (DPC), require a specific – symmetric - matching of the antenna. The feature cannot be used with an asymmetric matching that is used typically for other NFC Frontend ICs like the PN512.

NXP offers detailed application notes describing this principle in details, which very useful to adapt reader power performance to antenna interaction to contactless cards both in case of EMVCo payment both in simple access control: see [4], [5] and [6].

For best performance, a calibration of each individual IC under unloaded condition is required. In practice, this can be done during personalization of a reader in the production environment. Also during production tests, special fine-tuning is stored in specific register to take into account small variations from board to board.

The development board of the CLRC663 is not using the DPC feature by default. It requires an external circuitry described in another application note, named “NFC Reader Antenna Tuning: Analog DPC” [14], available in our confidential database <https://www.docstore.nxp.com>. NXP customers may register to this portal upon NDA signature agreement.

3.4.1 Additional resources

Recorded webinar on “Introduction to Dynamic Power Control AGC assessment and calibration using NFC Cockpit tool” valid only for PN5180; but same concept holds for Analog DPC without NFC Cockpit:

<http://www.nxp.com/video/:NXP-DPC-CORRELATION>

<http://www.nxp.com/video/:NXP-DPC-CALIBRATION>

3.5 NFC Cockpit with other MCUs

The NFC cockpit can be used together with other microcontrollers than the LPC1769 as well. In order to achieve this, a virtual com port interface (VCOM interface) is available in source code which can be ported to any other controller. The main porting work which is required relates to the adaption of the interface Host Microcontroller <-> PC. This allows connecting the CLRC663 to the application-specific host microcontroller directly on the application board and connect a PC running the NFC cockpit to the application-specific microcontroller. This is especially useful for fine-tuning of a register configuration without the need of additional software development.

3.5.1 Firmware update with NFC Cockpit

The CLRC663 supports the possibility to update the integrated firmware provided by NXP. The latest firmware is always supplied with the NFC Cockpit, which can be used to update PNEV5180B development boards. The latest – and all previous - versions of the firmware can be found on the NXP DocStore. The firmware is provided by NXP in binary form, pre-formatted for easy download. Please note that the host interface commands used for NFC operation of the CLRC663 and for the download mode are different. The CLRC663 is always able to recover from interrupted download operations, e.g. caused by a power supply interrupt. It is not possible to download modified or non-NXP firmware binaries to the CLRC663. A security system implemented in the CLRC663 accepts only the original firmware provided by NXP.

3.6 Low-Power Card Detection

LPCD capability, as introduced in previous readers (CLRC663 and derivatives), is also present in CLRC663 *plus* and derivatives, and its calibration and enabling can be also done through NFC Cockpit tool. More information can be found in [3] and [12].

3.7 CLRC663 register configurations and software optimization

3.7.1 CLRC663 Registers

As many other NXP front-end readers, CLRC663 includes registers which shall be configured by MCU state machine firmware in order to implement ISO protocol while executing customer application. All registry bank is described in detail in [CLRC663 datasheet](#), including whole description in chapter 8 (after page 60). For better control of analog performance of transmitted and received signals, NXP designed an executable aiming reader optimization (see next paragraph).

3.7.2 CLRC663 Rx Matrix Test

The performance of the final RFID system is heavily dependent on the register settings of the IC. NXP offers one tool, the MATRIX test, which allows to find the optimal register settings without deep knowledge of the IC internals. This is explained in the application note AN11849 “PN5180 Rx Matrix Test”, which explanation is also valid for CLRC663

families and their derivatives (only names of some registers might change from PN5180 to CLRC663, but principle is the same). It can be downloaded from [this link](#).

3.7.3 CLRC663 EEPROM

All EEPROM bank is described in detail in [CLRC663 datasheet](#), including several tables in chapter 7.7 – Memory (after page 44). Customer can manage EEPROM by using NFC Cockpit, which includes dumping of whole EEPROM bank in an XML file and the other way around (restoring Reader EEPROM by reading existent XML). For more info, see [2].

4 Software development of a prototype reader

4.1 Software development

At the same time as the Hardware development takes place, your software engineer can start writing MCU code using our NFC Reader Library, which includes support for every relevant type of transponders and other NFC objects (like other readers or mobile phones).

The NFC reader library comes with several application notes, see this [link](#), tutorials available in our online on-demand training library (click [here](#)). And NFC cockpit, as mentioned before (see webinar [Quick start with NFC Cockpit](#)), can help to test the register settings before implementing in SW.

4.2 NFC Reader Library

Alternatively, the CLEV6630A and CLEV663B can be used with the NXP Reader Library. The NXP reader library is written in C, can be installed immediately on the LPC1769. Special features, including interrupt-based event handling, Free RTOS support and MISRA-C compliancy, are provided along with the NFC Reader Library.

This Library API is organized in independent layers (see [7]) which helps a lot software engineers to build up own NFC application starting from bottom physical layers (digital interfaces connection between MCU and NFC frontend) until upper Application layers.

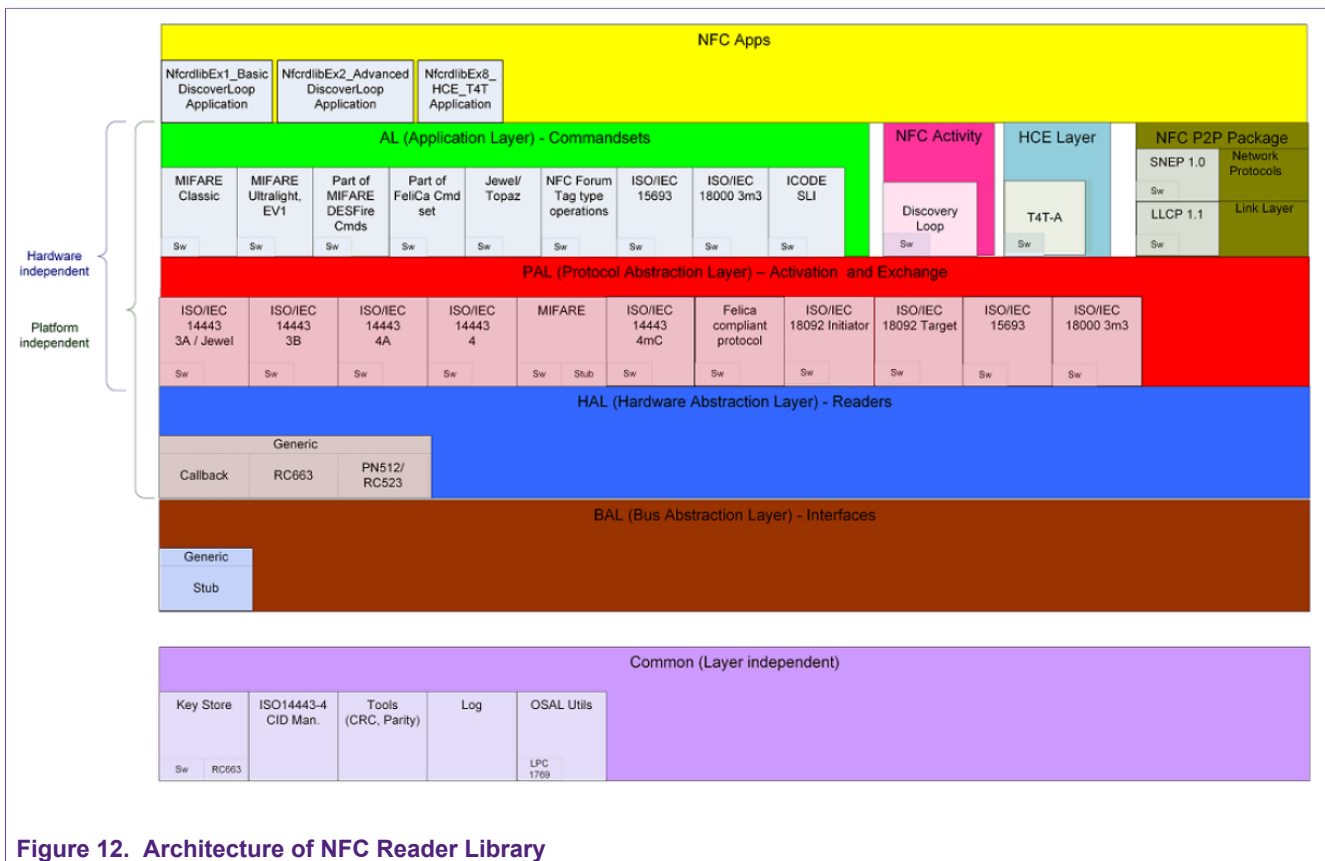

Figure 12. Architecture of NFC Reader Library

The NFC Reader Library software is designed in a way to be easily portable to many different microcontrollers.

The free of charge development environment MCUXpresso is used for compilation of the source code, see [NXP website](#). In order to download the compiled binaries to the LPC1769 which is implemented on the board, a debug interface [LPC-LINK2](#) is required. NXP reader library precompiled for the CLEV663A and B Boards can be found in [NXP website](#) (“[NFC Reader Library for CLRC663](#)”).

The NFC Reader library is free of charge as long as it is used together with NXP NFC products, and can be modified by developers according to their needs. It is not required to feedback modifications of the software to NXP. The detailed licensing conditions of the NFC Reader Library are included in the download package.

The library is available for LINUX or ANDROID-based systems as well. Such package contains the complete NFC Reader Library with the relevant layers ported to Linux. The download package is configured for the Raspberry Pi, but can be run on any Linux system, see [here](#) (“[NFC Reader Library for Linux](#)”).

Since LINUX and ANDROID use the same low-level kernel for the OS, the usage of this software package on ANDROID-based systems is possible with low software porting efforts.

More details about NFC Reader Library can be found in this on-demand webinar: <http://www.nxp.com/video:/NFC-APPS-SUPPORT-NFC-FRONTEND>.

4.3 Software applications as parallel support to contactless transponders

Given that all NFC reader customers also need to test and evaluate transponders, tags, contactless passive products and NFC connected tags, it is recommended to download and install utilities, such as:

4.3.1 Windows-based applications

[RFID-Discover](#), which interacts with [NXP PEGODA Contactless Smart Card Reader](#)
[TagXplorer PC based NFC Tag reader-writer tool](#), which can be used with following commercial readers:

- Advanced Card Systems: ACR1281
- HID Global: OMNIKEY 5022
- Identiv: uTrust 3700, uTrust 4701, CLOUD 3700
- NXP: Pegoda, Pegoda 2

4.3.2 NXP NFC Smartphone applications

[NXP Taginfo app](#): available in Google playstore for Android-based smartphones and in Apple store, for iPhones versions 7 and beyond, and operating system versions iOS11 and beyond.

[NXP Tagwriter app](#): available in Google playstore for Android-based smartphones.

5 Testing and debugging

For the sake of product development, NXP is committed to maintain current demo boards (HW and SW) allowing customers to implement their contactless functionality independent of RF & Analog performance; in this way, development engineer may test interaction between infrastructure and smartcards assuming reader is optimized in terms of RF. This is currently the aim of mentioned CLRC663 evaluation boards. Important testing resource is the already mentioned resources like LPCD dedicated application note, DPC concepts, all available in video repository in NXP public website:

<http://www.nxp.com/video/vault?searchLabel=renderHomepage>

All these recording sessions on NFC Cockpit can be used for application debugging and possibly for platform certification tests.

6 Getting Certified

As far as NFC forum is concerned, CLRC663 is not fully NFC-compliant because it supports partially Peer-to-peer functionality and does not support card-emulation like a full NFC device

Generally speaking, any NFC-equipped product starting from development and up to mass production stages shall take into account most important certification and compliancy standards, in order to be properly placed in the market.

Examples of most popular certifications are:

- [CE European conformity certification](#)
- NFC regulatory measurements, according to ETSI EN 302 291-1 V1.1.1 – now superseded by [EN 300 300](#)
- [EMVCo](#) L1 and L2 compliancy standards

Each of these standard bundles represents an important milestone in an NFC project. Depending on the use case and application, also multiple standards have to be considered during the design.

6.1 NXP resources on design for compliancy

6.1.1 NFC Forum and EMVCo

Customers can find on [3] a detailed explanation on antenna design for NFC Forum compliancy as well as for EMVCo Level 1 compliancy in terms of RF performance.

6.1.2 EMC approval and good RF performance

Customers can find on following webinar presentations and videos how to best develop own hardware toward good EMC behavior and maximize chances to be success in final qualification tests.

Table 2. NFC webinars on EMC design, Test & Qualification

Webinar Title		Agenda	Presentation & Recorded Webinar
1	Test & Qualification	<ul style="list-style-type: none"> • Which tests are required? • What are the required test tools? • References to ISO/IEC 14443, EMVCo & NFC-Forum 	Recorded Webinar Materials
2	EMC-related Design	<ul style="list-style-type: none"> • What is the impact of EMC? • What are the EMC critical parts of the design? • Basic rules to improve EMC behavior 	Recorded Webinar Materials

6.2 NXP partners for certification

In order to coach and support customers along certification process, NXP is promoting a list of partners with specific competencies on ISO/IEC certification, EMVCo L1/L2 and NFC Forum test pre-assessments (NXP Approved Engineering Consultants).

This list can be found here: <https://www.nxp.com/support/support/nxp-partner-directory:PARTNER-DIRECTORY?lang=en#/>

Select tab “Partner Directory”, add keyword NFC and select filters like country, services supported, devices supported, etc. Then press search to get contact info.

7 Available on-demand webinars on NFC technology as additional support to CLRC663 reader development

Archive of NXP on-demand webinars can be found in this [weblink](#). In particular, NFC-related webinars have been grouped together under cluster “Near Field Communication”.

8 Summary

For the sake of product development, NXP has developed several demo boards allowing customers to implement their contactless functionality independent of RF & Analog performance; this grants development engineer to test interaction between infrastructure and smartcards assuming reader is optimized in terms of RF. All above is covered by this document in relation to NXP CLRC663-equipped development kit and related hardware contained in the OM26630 FDK blister as well as other demoboards. The aim of whole document is to steer customer to consolidate this contactless functionality (for instance, access control or fare collection using contactless technologies as MIFARE products; payment applications or home banking; eGov reading of electronic passports, etc). After customer is convinced about application or functionality, NXP provides all necessary information so that customer can dedicate effort to synthesize reader HW and proceed to tests (analog and digital debugging) and further certification.

9 References

1. [NFC and Reader IC's](#)
2. [AN11022](#) - CLRC663 Evaluation board quick start guide and [AN11256](#) Migration guide CLRC663 to derivatives
3. [AN11019](#) – CLRC663, MFRC630, MFRC631, SLRC610 Antenna Design and [AN11535](#) - Measurement and tuning of an NFC and Reader IC antenna with a MiniVNA; there are also matching calculation spread sheets: [matching calculations](#) and [Directly matched antenna design – Advanced user](#)
4. [AN11741](#) - How to design an antenna with DPC
5. [AN11742](#) - Dynamic Power Control
6. Analog DPC - to be added
7. [AN11021](#) - CLRC663, MFRC631, MFRC630, SLRC610 Software Design Guide for NXPRDLib
8. [CLRC663 Datasheet](#) - High performance multi-protocol NFC frontend CLRC663 and CLRC663 *plus*
9. [SLRC610 and SLRC610 plus Datasheet](#) - High-performance ICODE frontend SLRC610 and SLRC610 *plus*
10. [MFRC630 and MFRC630 plus Datasheet](#) - MFRC630 and MFRC630 *plus*: High-performance frontend for MIFARE and NTAG products
11. [MFRC631 and MFRC631 plus Datasheet](#) - High-performance ISO/IEC 14443 A/B frontend MFRC631 and MFRC631 *plus*
12. [AN11783](#) - CLRC663 *plus* Low-Power Card Detection
13. AN11314 Multiple Antennas on Single Reader IC, available in DocStore: <https://www.docstore.nxp.com>
14. AN12531 NFC Reader Antenna Tuning: Analog DPC, available in DocStore: <https://www.docstore.nxp.com>

10 Legal information

10.1 Definitions

Draft — The document is a draft version only. The content is still under internal review and subject to formal approval, which may result in modifications or additions. NXP Semiconductors does not give any representations or warranties as to the accuracy or completeness of information included herein and shall have no liability for the consequences of use of such information.

10.2 Disclaimers

Limited warranty and liability — Information in this document is believed to be accurate and reliable. However, NXP Semiconductors does not give any representations or warranties, expressed or implied, as to the accuracy or completeness of such information and shall have no liability for the consequences of use of such information. NXP Semiconductors takes no responsibility for the content in this document if provided by an information source outside of NXP Semiconductors. In no event shall NXP Semiconductors be liable for any indirect, incidental, punitive, special or consequential damages (including - without limitation - lost profits, lost savings, business interruption, costs related to the removal or replacement of any products or rework charges) whether or not such damages are based on tort (including negligence), warranty, breach of contract or any other legal theory. Notwithstanding any damages that customer might incur for any reason whatsoever, NXP Semiconductors' aggregate and cumulative liability towards customer for the products described herein shall be limited in accordance with the Terms and conditions of commercial sale of NXP Semiconductors.

Right to make changes — NXP Semiconductors reserves the right to make changes to information published in this document, including without limitation specifications and product descriptions, at any time and without notice. This document supersedes and replaces all information supplied prior to the publication hereof.

Suitability for use — NXP Semiconductors products are not designed, authorized or warranted to be suitable for use in life support, life-critical or safety-critical systems or equipment, nor in applications where failure or malfunction of an NXP Semiconductors product can reasonably be expected to result in personal injury, death or severe property or environmental damage. NXP Semiconductors and its suppliers accept no liability for inclusion and/or use of NXP Semiconductors products in such equipment or applications and therefore such inclusion and/or use is at the customer's own risk.

Applications — Applications that are described herein for any of these products are for illustrative purposes only. NXP Semiconductors makes no representation or warranty that such applications will be suitable for the specified use without further testing or modification. Customers are responsible for the design and operation of their applications and products using NXP Semiconductors products, and NXP Semiconductors accepts no liability for any assistance with applications or customer product design. It is customer's sole responsibility to determine whether the NXP Semiconductors product is suitable and fit for the customer's applications and products planned, as well as for the planned application and use of customer's third party customer(s). Customers should provide appropriate design and operating safeguards to minimize the risks associated with their applications and products. NXP Semiconductors does not accept any liability related to any default, damage, costs or problem which is based on any weakness or default in the customer's applications or products, or the application or use by customer's third party customer(s). Customer is responsible for doing all necessary testing for the customer's applications and products using NXP Semiconductors products in order to avoid a default of the applications and the products or of the application or use by customer's third party customer(s). NXP does not accept any liability in this respect.

Export control — This document as well as the item(s) described herein may be subject to export control regulations. Export might require a prior authorization from competent authorities.

Non-automotive qualified products — Unless this data sheet expressly states that this specific NXP Semiconductors product is automotive qualified, the product is not suitable for automotive use. It is neither qualified nor tested in accordance with automotive testing or application requirements. NXP Semiconductors accepts no liability for inclusion and/or use of non-automotive qualified products in automotive equipment or applications. In the event that customer uses the product for design-in and use in automotive applications to automotive specifications and standards, customer (a) shall use the product without NXP Semiconductors' warranty of the product for such automotive applications, use and specifications, and (b) whenever customer uses the product for automotive applications beyond NXP Semiconductors' specifications such use shall be solely at customer's own risk, and (c) customer fully indemnifies NXP Semiconductors for any liability, damages or failed product claims resulting from customer design and use of the product for automotive applications beyond NXP Semiconductors' standard warranty and NXP Semiconductors' product specifications.

Evaluation products — This product is provided on an "as is" and "with all faults" basis for evaluation purposes only. NXP Semiconductors, its affiliates and their suppliers expressly disclaim all warranties, whether express, implied or statutory, including but not limited to the implied warranties of non-infringement, merchantability and fitness for a particular purpose. The entire risk as to the quality, or arising out of the use or performance, of this product remains with customer. In no event shall NXP Semiconductors, its affiliates or their suppliers be liable to customer for any special, indirect, consequential, punitive or incidental damages (including without limitation damages for loss of business, business interruption, loss of use, loss of data or information, and the like) arising out of the use of or inability to use the product, whether or not based on tort (including negligence), strict liability, breach of contract, breach of warranty or any other theory, even if advised of the possibility of such damages. Notwithstanding any damages that customer might incur for any reason whatsoever (including without limitation, all damages referenced above and all direct or general damages), the entire liability of NXP Semiconductors, its affiliates and their suppliers and customer's exclusive remedy for all of the foregoing shall be limited to actual damages incurred by customer based on reasonable reliance up to the greater of the amount actually paid by customer for the product or five dollars (US\$5.00). The foregoing limitations, exclusions and disclaimers shall apply to the maximum extent permitted by applicable law, even if any remedy fails of its essential purpose.

Translations — A non-English (translated) version of a document is for reference only. The English version shall prevail in case of any discrepancy between the translated and English versions.

Security — While NXP Semiconductors has implemented advanced security features, all products may be subject to unidentified vulnerabilities. Customers are responsible for the design and operation of their applications and products to reduce the effect of these vulnerabilities on customer's applications and products, and NXP Semiconductors accepts no liability for any vulnerability that is discovered. Customers should implement appropriate design and operating safeguards to minimize the risks associated with their applications and products.

10.3 Licenses

Purchase of NXP ICs with NFC technology

Purchase of an NXP Semiconductors IC that complies with one of the Near Field Communication (NFC) standards ISO/IEC 18092 and ISO/IEC 21481 does not convey an implied license under any patent right infringed by implementation of any of those standards. Purchase of NXP Semiconductors IC does not include a license to any NXP patent (or other IP right) covering combinations of those products with other products, whether hardware or software.

10.4 Trademarks

Notice: All referenced brands, product names, service names and trademarks are the property of their respective owners.

MIFARE — is a trademark of NXP B.V.

NTAG — is a trademark of NXP B.V.

Bluetooth — The Bluetooth word mark and logos are registered trademarks owned by Bluetooth SIG, Inc. and any use of such marks by NXP Semiconductors is under license.

Tables

Tab. 1. NXP webinars on antenna design 14 Tab. 2. NFC webinars on EMC design, Test & Qualification21

Figures

Fig. 1.	NFC Implementation Process	3	Fig. 10.	CLEV663B board follows main approach of PNEV5180B case; main board parts are: MCU, empty matching network and loop antenna	12
Fig. 2.	Blister containing OM26630FDK development kit	5	Fig. 11.	CLEV663A board used in an antenna multiplexer configuration based on MOSFETS: original demoboard is cut at the limit of matching network since antenna matching is developed on multiplexer PCB	14
Fig. 3.	CLEV6630AM development kit	6	Fig. 12.	Architecture of NFC Reader Library	18
Fig. 4.	BLE-NFC-V2 demo kit	6			
Fig. 5.	NFC Antenna Development kit	7			
Fig. 6.	NFC Cockpit snapshot	8			
Fig. 7.	Rectangular antenna calculations	11			
Fig. 8.	Circular antenna calculations	11			
Fig. 9.	Antenna tool developed by NXP	12			

Contents

1	Introduction	3	6.2	NXP partners for certification	21
1.1	Introduction to CLRC663, an NFC Front-end reader	3	7	Available on-demand webinars on NFC technology as additional support to CLRC663 reader development	23
1.1.1	Deciding on Reader functionality	4	8	Summary	24
2	Evaluating features	5	9	References	25
2.1	OM26630 FDK Development kit	5	10	Legal information	26
2.2	CLEV6630AM Development kit	6			
2.3	CLRC663 <i>plus</i> and QN902x NFC-Bluetooth® Low Energy solution for consumer applications	6			
2.4	OM29263ADK: NFC Antenna Development Kit	7			
2.5	NFC Cockpit use with OM26630FDK and CLEV6630AM	8			
2.5.1	Additional resources: recorded webinar on “Introduction to NFC Cockpit tool”	8			
2.6	Application notes and data sheet	8			
2.7	Additional resources: recorded webinars on CLRC663 family	9			
3	Hardware development of a prototype reader	10			
3.1	RF reader design and matching between RF output and customer antenna	10			
3.1.1	Antenna design guide	10			
3.1.1.1	Rectangular antenna calculations	10			
3.1.1.2	Circular antenna calculations	11			
3.1.1.3	Online antenna tool	11			
3.1.2	Development kit preparation for matching	12			
3.2	Antenna multiplexing concept	13			
3.3	Antenna design additional information	14			
3.4	Analog Dynamic Power Control	15			
3.4.1	Additional resources	15			
3.5	NFC Cockpit with other MCUs	16			
3.5.1	Firmware update with NFC Cockpit	16			
3.6	Low-Power Card Detection	16			
3.7	CLRC663 register configurations and software optimization	16			
3.7.1	CLRC663 Registers	16			
3.7.2	CLRC663 Rx Matrix Test	16			
3.7.3	CLRC663 EEPROM	17			
4	Software development of a prototype reader	18			
4.1	Software development	18			
4.2	NFC Reader Library	18			
4.3	Software applications as parallel support to contactless transponders	19			
4.3.1	Windows-based applications	19			
4.3.2	NXP NFC Smartphone applications	19			
5	Testing and debugging	20			
6	Getting Certified	21			
6.1	NXP resources on design for compliancy	21			
6.1.1	NFC Forum and EMVCo	21			
6.1.2	EMC approval and good RF performance	21			

Please be aware that important notices concerning this document and the product(s) described herein, have been included in section 'Legal information'.

© NXP B.V. 2019.

All rights reserved.

For more information, please visit: <http://www.nxp.com>

For sales office addresses, please send an email to: salesaddresses@nxp.com

Date of release: 9 July 2019

Document identifier: AN12334

Document number: 523210