



SOT340-1

SSOP24; Reel pack; SMD, 13"
 Q1/T1 Standard product orientation
 Orderable part number ending ,118 or J
 Ordering code (12NC) ending 118

Rev. 1 — 5 April 2013

Packing information

1. Packing method

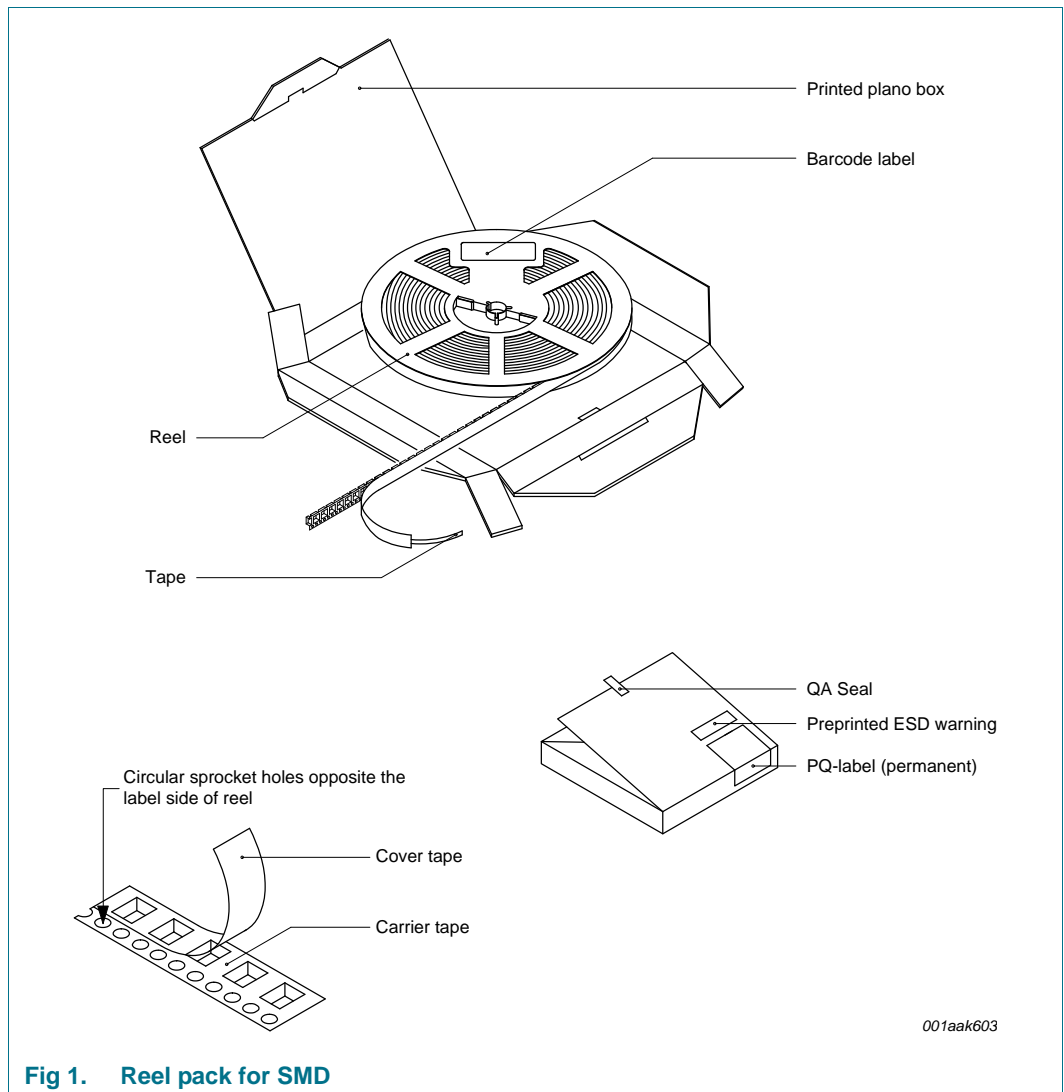

Fig 1. Reel pack for SMD

Table 1. Packing information

Reel dimensions d x w (mm)	SPQ/PQ (pcs)	Reels per box	Outer box dimensions l x w x h (mm)
330 x 16	1000	1	341 x 338 x 30



SSOP24; Reel pack; SMD, 13"
 Q1/T1 Standard product orientation
 Orderable part number ending ,118 or J
 Ordering code (12NC) ending 118

2. Product orientation

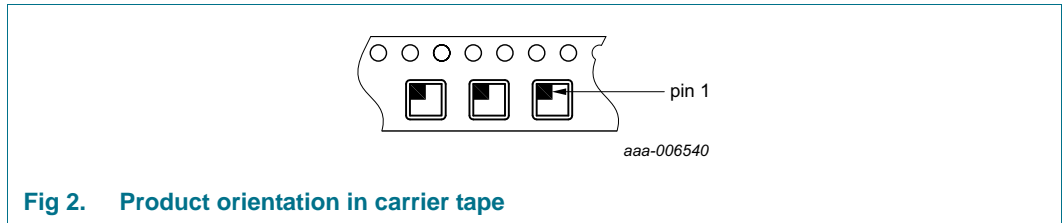

Fig 2. Product orientation in carrier tape

3. Carrier tape dimensions

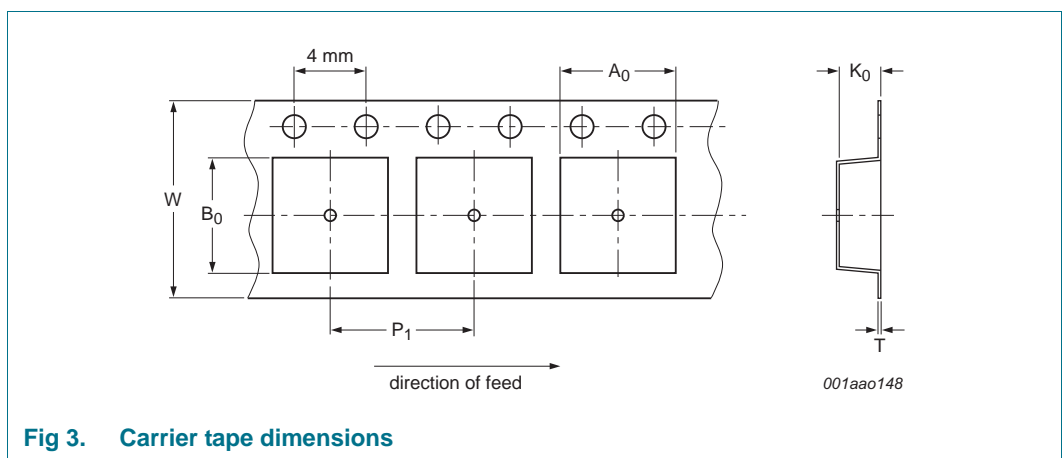

Fig 3. Carrier tape dimensions

Table 2. Carrier tape dimensions

In accordance with IEC 60286-3.

A ₀ (mm)	B ₀ (mm)	K ₀ (mm)	T (mm)	P ₁ (mm)	W (mm)
8.2	8.8	2.5	-	12	16

SSOP24; Reel pack; SMD, 13"
 Q1/T1 Standard product orientation
 Orderable part number ending ,118 or J
 Ordering code (12NC) ending 118

4. Reel dimensions

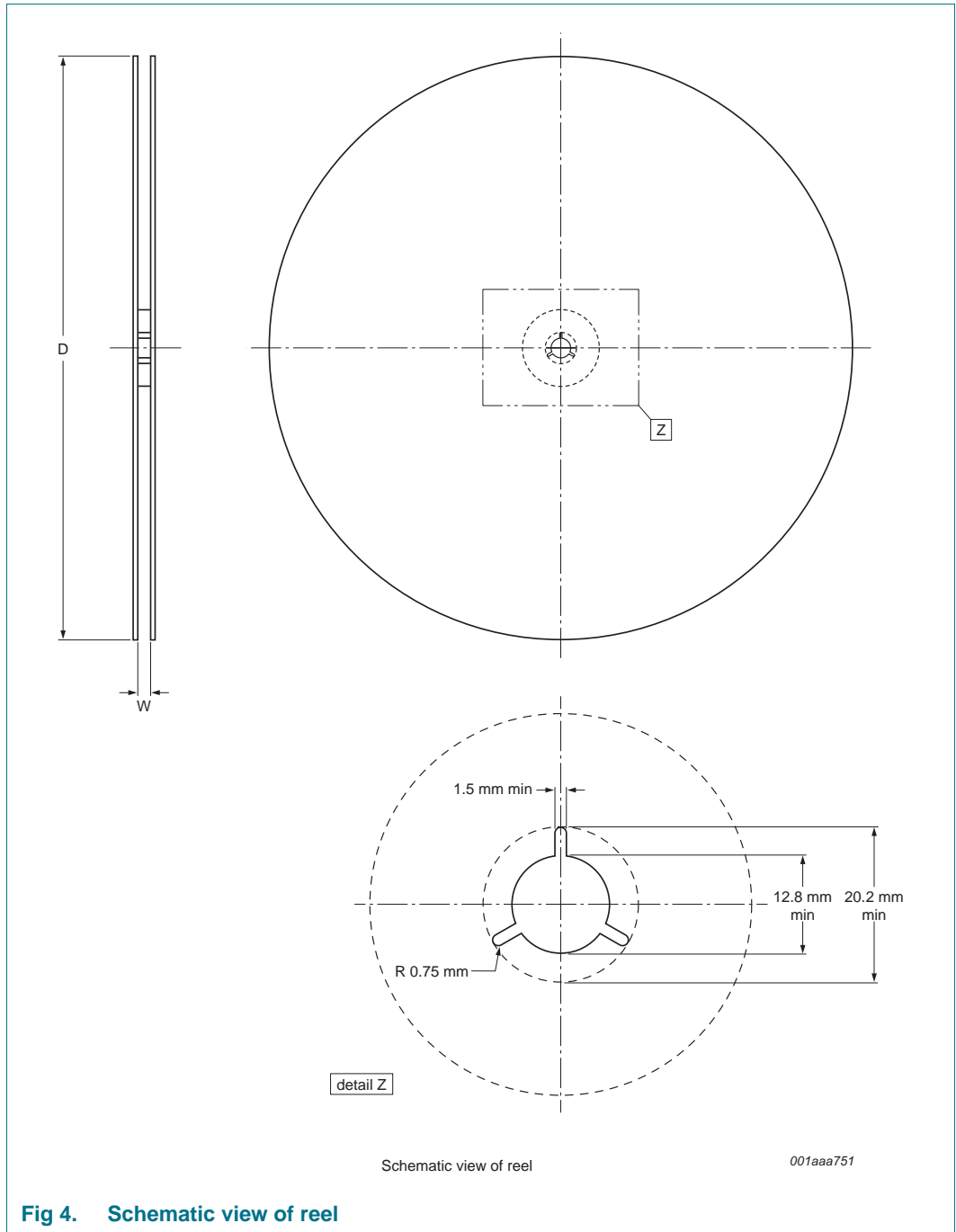

Fig 4. Schematic view of reel

Table 3. Reel dimensions
 In accordance with IEC 60286-3.

D (mm)	W (mm)
330	16

SSOP24; Reel pack; SMD, 13"
 Q1/T1 Standard product orientation
 Orderable part number ending ,118 or J
 Ordering code (12NC) ending 118

5. Barcode label

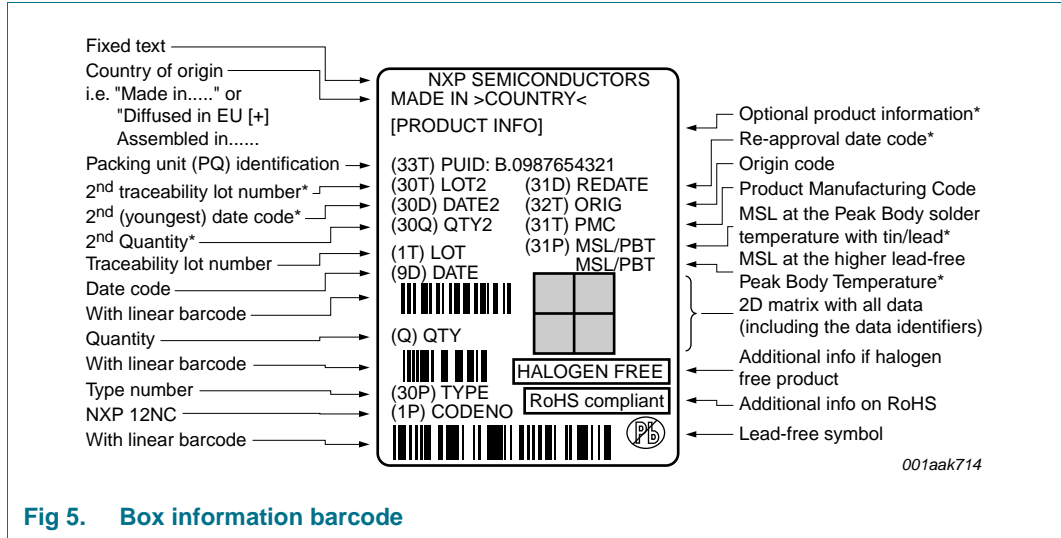

Fig 5. Box information barcode

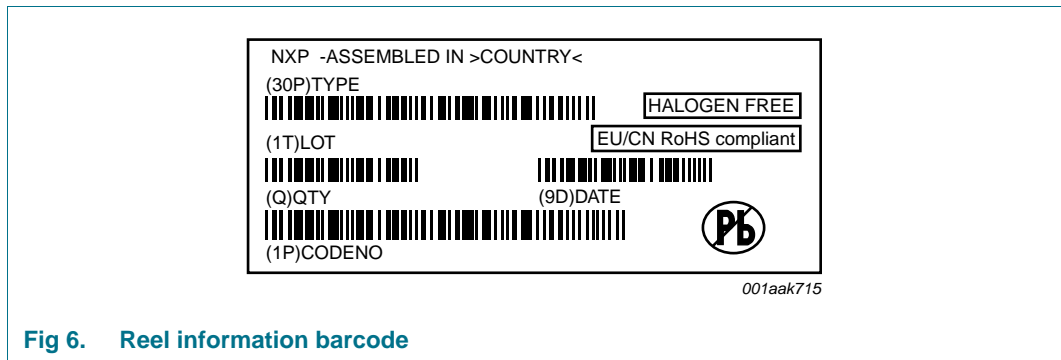

Fig 6. Reel information barcode

Table 4. Barcode dimensions

Box barcode label l x w (mm)	Reel barcode label l x w (mm)
100 x 75	35 x 75

Limited warranty and liability

Information in this document is believed to be accurate and reliable. However, NXP Semiconductors does not give any representations or warranties, expressed or implied, as to the accuracy or completeness of such information and shall have no liability for the consequences of use of such information.

© NXP B.V. 2013.

For more information, please visit: <http://www.nxp.com>
 For sales office addresses, please send an email to: salesaddresses@nxp.com

All rights reserved.

Date of release: 5 April 2013
 Document identifier: SOT340-1_118